

Measurement Good Practice Guide

The Use of GTEM Cells for EMC Measurements

Angela Nothofer, Martin Alexander

National Physical Laboratory

Didier Bozec, Andy Marvin,

Les McCormack

York EMC Services Ltd., UK

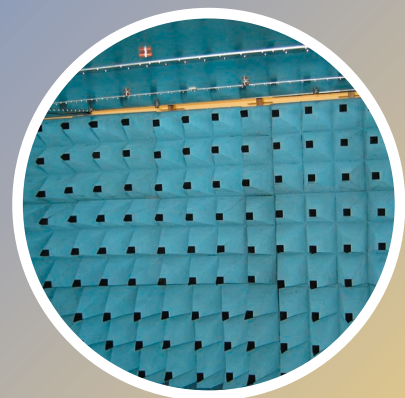

York **EMC** Services Ltd

NPL 
National Physical Laboratory

Measurement Good Practice Guide No. 65

The Use of GTEM Cells for EMC Measurements

Angela Nothofer*, Didier Bozec**, Andy Marvin**

Martin Alexander*, Les McCormack**

* National Physical Laboratory, UK

**York EMC Services Ltd., UK

Abstract: This guide is aimed at users of GTEM cells. Its purpose is to help them achieve good practice in EMC emission and immunity tests with their GTEM cell. Reference is made to the IEC Standard 61000-4-20 on the EMC uses of GTEM cells.

© Crown Copyright 2003
Reproduced by permission of the Controller of HMSO

ISSN 1368-6550

January 2003

National Physical Laboratory
Teddington, Middlesex, United Kingdom, TW11 0LW

Website: www.npl.co.uk

Acknowledgements

This project was sponsored by the National Measurement System Policy Unit of the Department of Trade and Industry as part of the NMS Electrical Programme 2000-2003. The work was carried out by staff of the National Physical Laboratory and York EMC Services Ltd. Members of the UK GTEM Users' Group provided input on the practical use of GTEM cells for EMC testing and EMC Hire Ltd. repeated the emission measurements in their GTEM cell.

The Use of GTEM Cells for EMC Measurements

Contents

1	Scope and structure of the guide.....	1
2	Introduction	2
2.1	History and development of the GTEM cell	2
2.2	The GTEM cell in the EMC testing standards	3
2.3	The advantages of GTEM cells compared to other test environments	4
3	General GTEM validation and maintenance.....	6
3.1	Field uniformity requirements according to IEC 61000-4-20.....	6
3.2	Field uniformity measurements.....	7
3.2.1	Measurement setup.....	7
3.2.2	Typical field uniformity results.....	8
3.2.3	The longitudinal mode	10
3.2.4	Damping the TM_{111} resonance using ferrite tiles	11
3.2.5	Alternative method for field uniformity test	12
3.2.6	Using the alternative method to investigate cross-polar coupling	13
4	Emission measurements.....	16
4.1	Measurement setup.....	16
4.2	GTEM to OATS correlation.....	17
4.3	Typical correlation results.....	18
4.3.1	The EUTs	18
4.3.2	The test sites	19
4.3.3	Results for the CNE III.....	22
4.3.4	Results for the CNE VII.....	22
4.3.5	Results for the REUTE up to 2 GHz	23

4.3.6	Results for the REUTE from 1.5 GHz up to 6 GHz.....	25
4.4	Comparison of results from three different GTEM cells	26
4.5	Sources for measurement uncertainties.....	27
4.5.1	Effect of repositioning the REUTE in the GTEM.....	27
4.5.2	Effect of linear displacement.....	28
5	Example uncertainty budgets.....	30
6	Hints and tips.....	31
6.1	Saves on building space	31
6.2	You can move it	31
6.3	It is screened.....	31
6.4	Low level dynamic range	31
6.5	It has its own fan, but this can present a noise problem.....	31
6.6	Earth currents – hum	32
6.7	Windows.....	32
6.8	Penetration plate requirements.....	32
6.9	Protecting the RAM	32
6.10	Rotating the EUT	32
6.11	Observing the EUT display	33
6.12	Choosing the amplifier	33
6.13	Choosing the power sensor	33
6.14	Connect susceptible test equipment outside the cell.....	34
6.15	What is the turntable made of	34
6.16	Putting light in the cell	34
6.17	Cleaning the door	35
6.18	Incline the table	35

6.19	Remote actuation.....	35
6.20	Coping with liquids	35
6.21	How to route cables.....	35
6.22	How to terminate cables.....	36
7	Conclusions	37
8	References	38
9	Glossary.....	40
Appendix 1	Higher order modes in TEM waveguides	42
Appendix 2	Field uniformity measurements	44
A2.1	Definition of uniform area.....	44
A2.2	Procedure to measure uniform field area	45

1 Scope and structure of the guide

This guide is aimed at users of Gigahertz Transverse Electromagnetic (GTEM) cells. Its purpose is to help them achieve good practice in Electromagnetic Compatibility (EMC) emission and immunity tests with their GTEM cell. It can also help manufacturers decide whether a GTEM cell is suitable for testing their product and which cell size they would need.

The guide draws on work done by the National Physical Laboratory (NPL) and York EMC Services Ltd (YES) to study measurements in GTEM cells used for EMC emission and immunity testing, especially at frequencies above 1 GHz [1].

An introduction to the principle of the GTEM cell is given in Section 2. A brief summary of the historical development of Transverse Electromagnetic (TEM) cells is presented and their evolution as tools for EMC emission and immunity testing is outlined. GTEM cell sizes and manufacturers are listed.

The maintenance and general performance tests for GTEM cells are described in **Section 3**. This section includes the field uniformity test for TEM cells, as required by the International Standard IEC 61000-4-20 [2].

The measurement setup for emission tests is described in Section 4. This includes the orientations of the Equipment Under Test (EUT) inside the GTEM. Some typical GTEM to Open Area Test Site (OATS) results are presented. An example uncertainty budget is presented in **Section 5**, and in **Section 6** further hints and tips on the use of GTEM cells are listed.

An *italic* font is used for quotes from IEC standards. See the Glossary for acronyms and definitions.

2 Introduction

The GTEM cell, a high frequency version of the TEM cell, is a widely used alternative facility for EMC testing. According to IEC 61000-4-3 [3], the standard environment for radiated immunity tests is a screened enclosure, “*large enough to accommodate the EUT whilst allowing adequate control over the field strength.*” This is preferably an anechoic chamber large enough to allow a separation of 3 m between the transmitting antenna and the EUT. However, alternative methods are permitted, provided they fulfil the field requirements.

In both, emission and immunity measurements, the minimum distance of 3 m between antenna and EUT is required to ensure far field conditions. Since far field conditions also describe a TEM wave, alternative test environments that provide TEM wave propagation are accepted for EMC tests. A wide range of TEM waveguides is used for this purpose.

In Section 2.1 a brief background of the development of GTEM cells is outlined and a list of currently available GTEM cells is given. Section 2.2 describes how the GTEM cell is treated in the standards, and in Section 2.3 the advantages, and disadvantages, of GTEM cells compared to other test environments are listed.

2.1 History and development of the GTEM cell

Earliest TEM waveguides were open striplines used for immunity measurements [4]. They consist of two parallel conducting plates, with a voltage applied at one end and the other end terminated with the conductor’s characteristic impedance. To protect the environment from the electromagnetic radiation generated with open striplines, they generally have to be operated within screened rooms.

To avoid the necessity of the screened rooms, closed TEM cells were developed. Many TEM cells are built like the classic “*Crawford Cell*” which was first presented in 1974 [5]. They consist of a central rectangular part and two tapered parts ending in connectors. The frequency limitation of cells like this is caused by the transitions between the rectangular and the tapered part: at these transitions higher order modes can be excited, which disturb the TEM wave propagation. However at frequencies below the onset of the first resonance the TEM cell is capable of giving fields that are calculable, with low uncertainties, from the power into the cell. More about higher order modes can be found in Appendix 1.

In order to avoid a cavity, that limits the top frequency, the GTEM (**G**igahertz-**TEM**) cell was developed in 1984 by Asea Brown Boveri Ltd. in Switzerland [6]. The GTEM cell comprises only a tapered section, with one port and a broadband termination. This termination consists of a 50 Ω resistor board for low frequencies and pyramidal absorbers for high frequencies. The absorbers are arranged on a section of a sphere so that the tips of the absorber point towards the apex of the GTEM cell.

In classic Crawford TEM cells the inner conductor, or septum, is located centrally inside the cell. In GTEM cells the septum is within the upper third of the cell, allowing for a larger test volume beneath the inner conductor.

GTEM cells are commercially available in different sizes. Often, the model name of a GTEM cell indicates its size. For example, a GTEM 1250 by Lindgren-Rayproof has a septum height of 1250 mm, measured vertically from the floor at the termination. Its outer dimensions are 6 m length, 3 m width, and 2.5 m height.

Generally available are GTEM cells with a maximum septum height between 250 mm and 2000 mm. A specially built cell, the GTEM 3750 at the Defence Technology and Procurement Agency in Bern, Switzerland [7], has a septum height of 3.75 m. A list of different GTEM cells is given in the table below.

Manufacturer	Model	Outer Dimensions (m)
ETS - EMCO	5402	1.4 x 0.75 x 0.5
	5405	3.0 x 1.6 x 1.7
	5407	4.0 x 2.16 x 2.06
	5311, 5411	5.4 x 2.8 x 2.3
	5317	7.7 x 4.1 x 3.1
ETS – Lindren-Rayproof	250	1.4 x 0.75 x 0.5
	500	2.9 x 2.9 x 1.6
	750	4.0 x 2.0 x 1.95
	1250	6.0 x 3.0 x 2.5
	1750	8.0 x 4.0 x 3.2
Schaffner	250	1.25 x 0.65 x 0.45
	500	2.95 x 1.48 x 2.0
	750	3.95 x 2.02 x 2.15
	1000	4.95 x 2.54 x 2.13
	1250	5.95 x 3.06 x 2.48
	1500	6.95 x 3.58 x 2.55
	1750	7.95 x 4.1 x 2.9
	2000	8.95 x 4.62 x 3.24

Table 1: Overview of commercially available GTEM cells

This table shows GTEM cells sold by different manufacturers in the UK. This is just a selection of currently available cells and does not claim to be complete. All information was taken in December 2002 from <http://www.ets-lindgren.com/> for ETS – EMCO cells, from <http://www.lindgren-rayproof.com/> for ETS Lindren-Rayproof cells, and from <http://www.schaffner.com/> for Schaffner cells

2.2 The GTEM cell in the EMC testing standards

The IEC standard 61000-4-3 [3] treats testing and measurement techniques for radiated, radio frequency, electromagnetic field immunity tests. In its informative Annex D: “*Other test methods – TEM cells and striplines*” GTEM cells are mentioned as a suitable test environment. In this standard, it is requested that “*the field homogeneity requirements are met*” and “*the arrangement of the EUT and associated wiring cannot exceed one-third of the dimension between the septum and outer conductor*”. Furthermore, it is required that “*the EUT should be rotated in the TEM cell in order to test both horizontal and vertical positions.*”

This annex may, however, soon be replaced by a new section 61000-4-20 [2]. This new section treats both emission and immunity testing in TEM waveguides. This Good Practice Guide is focused on measurements according to 61000-4-20.

2.3 The advantages of GTEM cells compared to other test environments

The standard environments for EMC measurements are an anechoic chamber for radiated immunity tests and the open area test site (OATS) for radiated emission tests. The open area test site can be easily modelled assuming an infinite perfect ground plane and coupling between simple dipole antennas, but it has some disadvantages that must be taken into account:

- For an OATS with a good performance, a large obstruction free area is required with a flat ground and an extensive metallic ground plane. Nearby buildings and trees can lead to measurement errors. A GTEM cell requires comparatively little space and is also generally cheaper than building an OATS, which includes the cost of an area land at a distance from reflecting obstacles.
- Ambient RF interference (e.g. broadcasting signals) can be a major defect of an OATS, since it can be impossible to measure the EUT signal at some frequencies. GTEM cells are fully closed and do not suffer from ambient noise.
- The time taken to set up equipment and cables on the OATS can be lengthy.
- Since the GTEM cell itself functions as a receiving structure, no antenna setup is required. This makes the test setup simpler than on an OATS, and avoids the need to change the receiving antennas for different frequency ranges.
- Immunity tests have to be performed inside a screened environment, such as a GTEM cell and therefore can not be carried out on an OATS.

The GTEM cell also has some advantages over the anechoic chamber for emission and immunity tests:

- An anechoic chamber requires more space and is more expensive than a GTEM cell.
- Since the cell itself creates the field, no antennas are required for immunity tests inside a GTEM. By reciprocity, the cell functions as a receiving structure in emission tests. In an anechoic chamber the transmitting or receiving antennas have to be changed for different frequency ranges.
- Less amplification is required to generate a certain field strength in a GTEM cell than in an anechoic chamber. For example at 1 GHz a power of 9.5 W is needed into a log antenna to achieve 10 V/m at a range of 3 m compared with 2 W into a GTEM 1100 at a septum height of 1 m.
- On an OATS the procedure only mandates rotation of the EUT in the azimuth plane. The procedure in a GTEM cell is to rotate the EUT about three orthogonal axes so that emissions in all directions are measured (this is only strictly true where the EUT size is small compared to the wavelength).

Advantages of the Crawford cell compared to a GTEM are its high accuracy and a higher versatility of possible measurements due to the second port. The GTEM to OATS correlation used in emission measurements assumes all components of the EUT's radiation to be in phase, which may not always be the case. This is because the relative phase of the field components cannot be determined from a measurement in a single port device, such as the GTEM cell. It is, however, possible to obtain the relative phase of the field components from measurements in a two-port TEM cell. The upper frequency for TEM cells is limited by resonance of propagating higher-order modes. Although these modes also exist in the GTEM, the use of a single taper and an absorber lined end wall prevents resonance occurring. The calculation of the cut-off frequency of higher-order modes is described in Appendix 1.

The disadvantages of the GTEM cell are:

- The cross-polarisation performance is inferior to an anechoic chamber or OATS. Over a limited frequency band the field level of the longitudinal mode can exceed the level of the intended vertical field.
- The size of EUT is limited to approximately one third height between the septum and floor.

3 General GTEM validation and maintenance

The GTEM cell is an easy to maintain test equipment. However, some regular checks are required to ensure its correct performance:

- The door seals should be regularly checked for damage and occasionally cleaned. If the finger strips are damaged over large areas they ought to be replaced.
- The port connectors should be kept clean. Small objects, like polystyrene particles in the connector can lead to significant signal losses. This applies, of course, also to RF cables connected to the port. Their connectors should be kept clean and the cable losses should be known. At frequencies of 1 GHz and above, a few metres of a good RF cable can have a loss of several decibels.
- When moving an EUT inside the GTEM, great care should be taken not to damage the absorbers, the resistor boards, or the septum. If in doubt, the GTEM manufacturer should be asked to measure the characteristic impedance of the GTEM. A displacement of the septum, for example, can result in a change of the 50 Ω characteristic impedance. This can lead to disturbances of the field uniformity and significant measurement uncertainties. If the absorbers are covered by polystyrene blocks, they should stay in place to protect the absorbers.
- If the GTEM is used for immunity measurements, the field uniformity has to be checked regularly. This test should be performed according to IEC 61000-4-20 as described below.

3.1 Field uniformity requirements according to IEC 61000-4-20

The TEM waveguide standard IEC 61000-4-20, in the version dated August 2002, refers to IEC 61000-4-3, where an incident plane wave is required for immunity testing. This standard describes a test to gauge the field uniformity of a defined area. In TEM waveguides, the TEM mode is equivalent to an incident plane wave with a vertical electric field between the plates. In a GTEM cell the TEM mode has a slight spherical curvature; secondary (horizontal and longitudinal) field components are a sign that higher order modes (other than the TEM mode) are present, which further distorts the wave front.

Therefore, additional tests have to be performed to demonstrate that the secondary field components are lower than the primary field component by a certain amount. This has to be the case over a certain area inside the GTEM cell. This area, called the “*uniform area*”, is according to IEC 61000-4-20 “*a hypothetical vertical plane [orthogonal] to the propagation direction of the field*”. In a GTEM cell, this is represented by a plane perpendicular to the cell floor. In this area the field strength also has to be “uniform”, in other words variations in the field strength have to be small. This ensures that the face of the EUT is evenly illuminated.

The uniform area has to be calibrated for the frequency range that the GTEM is to be used, starting at 30 MHz and incrementing in 1% steps up to at least 1 GHz. The number of calibration positions depends on the size of the uniform area as shown in Appendix 2. The cell should be empty (apart from the field sensor and a turntable or manipulator) during this calibration.

The relevant text for defining and measuring the uniform area is copied from IEC 61000-4-20 in Appendix 2. Some discussions were still ongoing, whether the *primary* (vertical) or the *resultant* field strength should be taken as reference. Since the resultant field is calculated by means of the sum of the squares of the three components, this option is relaxing the requirement, as will be demonstrated in the results in Section 3.2. Therefore, the authors of this guide consider it “good practice” to take the primary field strength as the reference rather than the resultant field strength. This also corresponds better with the TEM mode or plane wave requirement described above.

3.2 Field uniformity measurements

IEC 61000-4-20 has a procedure for achieving a uniform field, which is reproduced in Appendix 2.2.

An equivalent procedure is to establish a constant resultant electric field strength in the range 3 V/m to 10 V/m and record the forward power delivered to the input port. The principles outlined in 1), 4), 5), 6) and 7) of Appendix 2.2 are still adhered to. This method is known as the “constant field strength method”.

The calibration is valid for all EUTs whose individual faces (including any cabling) can be fully enclosed by the “uniform area”. It is intended that the full uniform area calibration be carried out annually only, or when changes have been made to the enclosure configuration (i.e. GTEM cell, TEM cell, or stripline within a shielded enclosure).

3.2.1 Measurement setup

A typical test setup for uniformity measurements according to the procedure described above is shown in Figure 1. The software control records the field strength detected by the field probe and the power inserted into the GTEM cell while it regulates the output power and the frequencies of the signal generator.

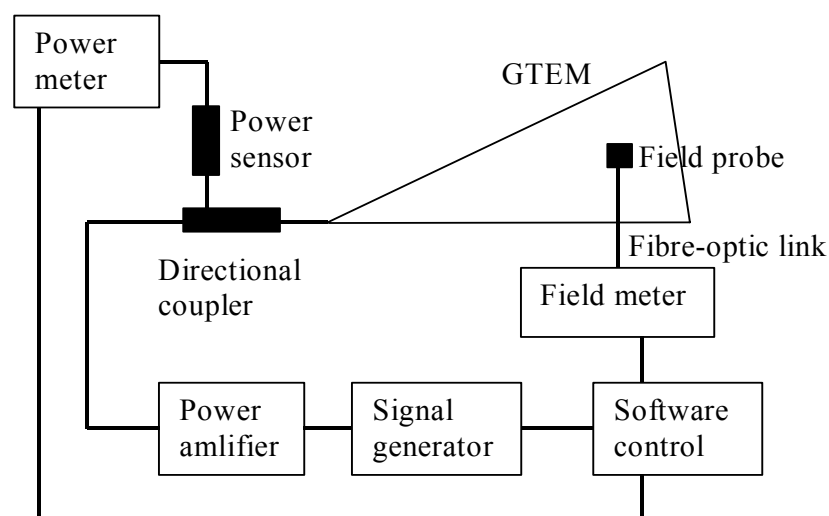

Figure 1: Setup for field uniformity test

3.2.2 Typical field uniformity results

An example result for a uniformity test performed according to this procedure is shown in Figure 2. In this case the “constant field strength method” was used for a vertical electric field strength of 10 V/m. The size of the grid is 583 mm x 583 mm at a septum height of 1049 mm in a GTEM 1750 manufactured by MEB (now Schaffner). A 9-point grid was used, and at each frequency two points with the highest diversity were disregarded. The maximum difference in power for the remaining 7 points is shown in Figure 2. It can clearly be seen that the GTEM cell is well within the 6 dB tolerance up to 2300 MHz with a single higher difference at 1500 MHz.

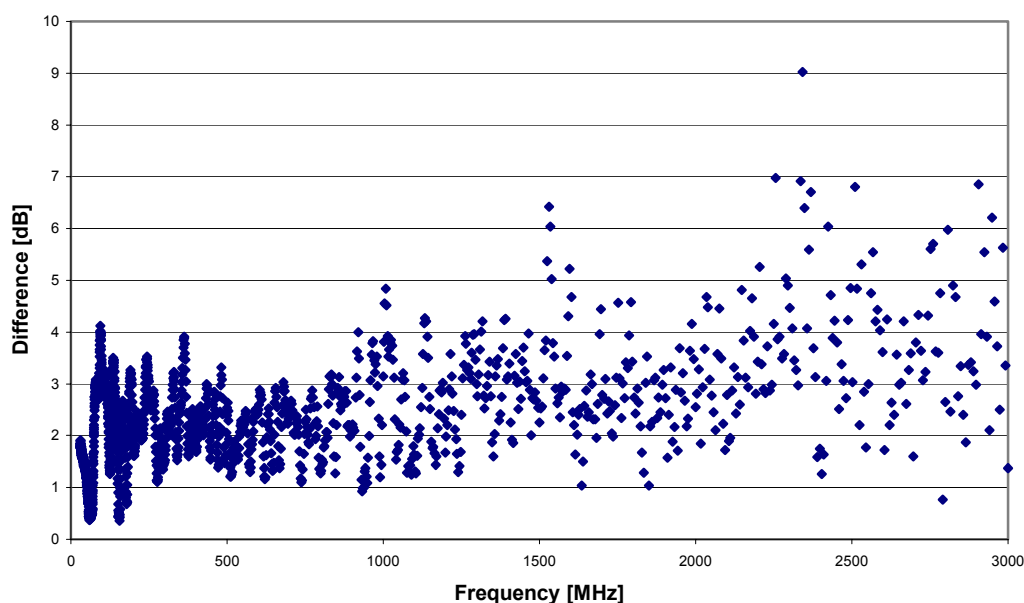

Figure 2: Maximum power difference for 7 of 9 points, with reference to the primary field strength

The cross-polar coupling for this test is shown in Figure 3 relative to the primary (vertical) field strength and in Figure 4 relative to the resultant field strength. In this case the 2 points of the grid with the maximum cross-polar component were disregarded at each frequency and the result for the highest of the remaining values is displayed.

According to IEC 61000-4-20 *the level of the secondary field components shall not exceed -6 dB of the resultant field and a secondary electric field component up to -2 dB of the resultant field, is allowed for a maximum of 3 % of the test frequencies.*

For both figures, it can be seen that these requirements are met up to a frequency of 2200 MHz, with an exception around 120 MHz where the longitudinal component becomes too large. But it can also be seen that the cross-polar coupling relative to the resultant field is smaller than relative to the primary field. In particular, the separation relative to the resultant field can never become positive, since a single field component can never become larger than the resultant of all three components. This demonstrates that the comparison to the vertical field is more severe than the comparison to the resultant field.

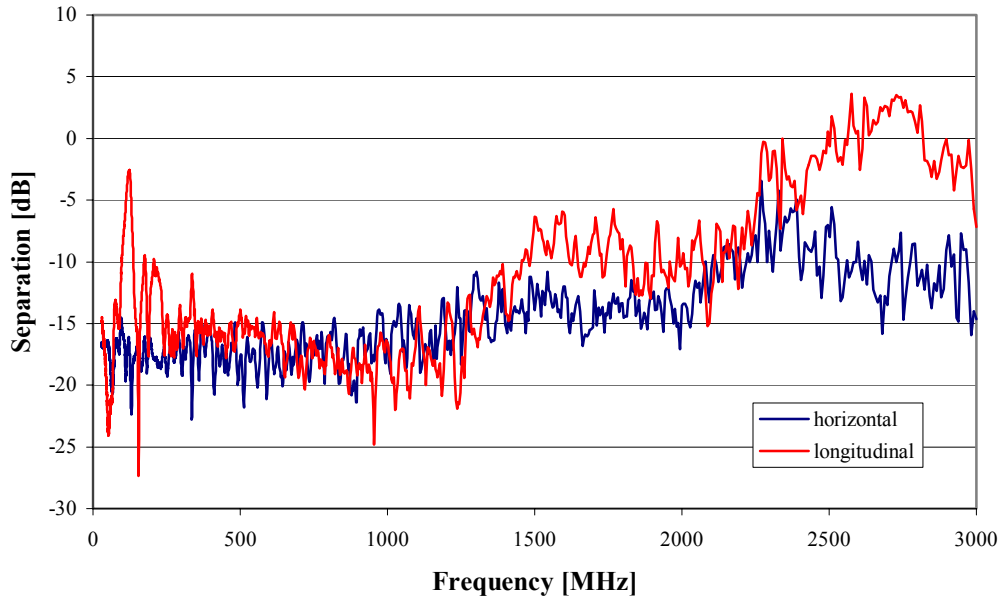

Figure 3: Cross-polar coupling relative to the vertical field strength for 7 of 9 points

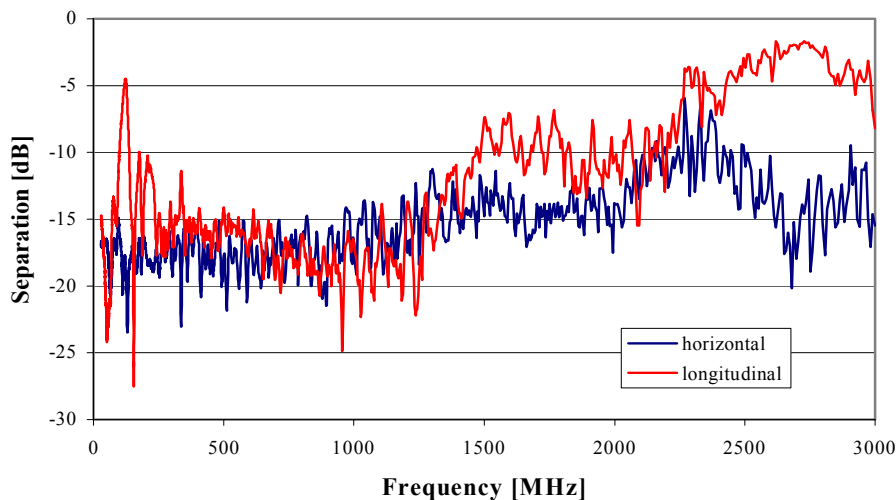

Figure 4: Cross-polar coupling relative to the resultant field strength for 7 of 9 points

The longitudinal field component in the GTEM 1750 and the nature of the termination of the cell were examined in [8], and the results of this paper are given below. Measurements of the spatial distribution of the longitudinal field were made using the Tokin Robust Optical Electric Field Sensor (ROEFS) system, which does not perturb the fields being measured.

The field components at the centre of the test volume in the GTEM 1750 are shown in Figure 5. It was found that the poorest cross-polar performance for the cell occurs at 125.5 MHz, where the ratio of the longitudinal to vertical field components is 1 dB. The maximum longitudinal field occurs at 127.25 MHz.

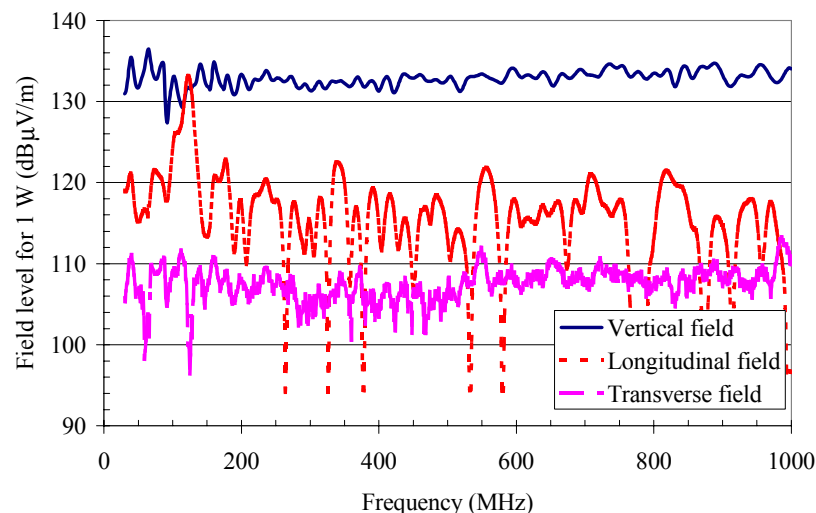

Figure 5: Field components in the GTEM 1750

3.2.3 The longitudinal mode

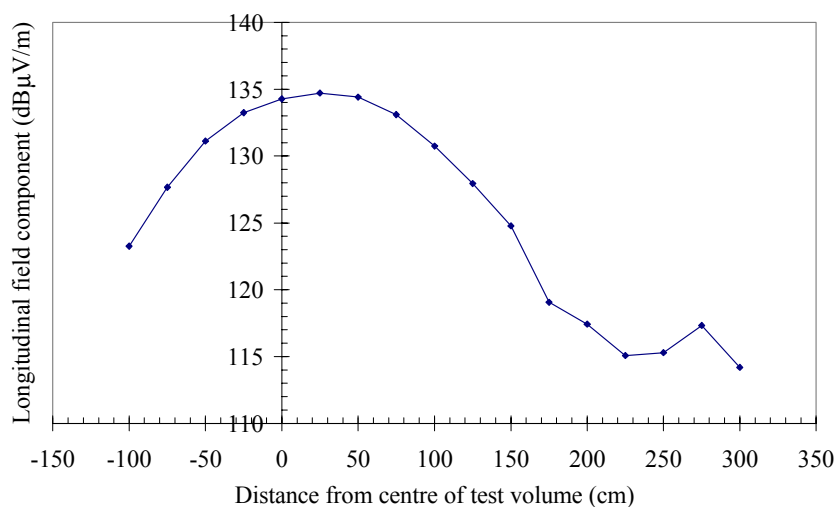

Figure 6: Variation of longitudinal field component along the axis of the cell, 1W input power

Figure 6 shows the variation in the longitudinal field along the axis of the GTEM cell at 127.275 MHz. The tips of the absorbers correspond to a displacement of -100 cm, 0 is the centre of the test volume and $+300$ cm is the measurement position nearest to the apex of the cell. Transverse and vertical scans show that there is a single maximum at the centre, and this confirms that there is a TM_{111} resonance in the cell at this frequency. Measurements showed that no significant longitudinal field is present above the septum, or in the gap between the edge of the septum and the sidewalls of the GTEM.

3.2.4 Damping the TM_{111} resonance using ferrite tiles

In [8] it was proposed that the TM_{111} resonance can be damped by placing ferrite tiles on the floor of the GTEM cell under the region where the maximum longitudinal E-field occurs. Sixty-four ferrite tiles, with dimensions 100 mm by 100 mm by 6.5 mm, were placed on the floor in a square beneath the test volume of the GTEM cell. The cross-polar performance of the cell at the centre of the test volume is shown in Figure 7. The results show that the tiles have improved the cross-polar performance for the cell by 7 dB at 125 MHz.

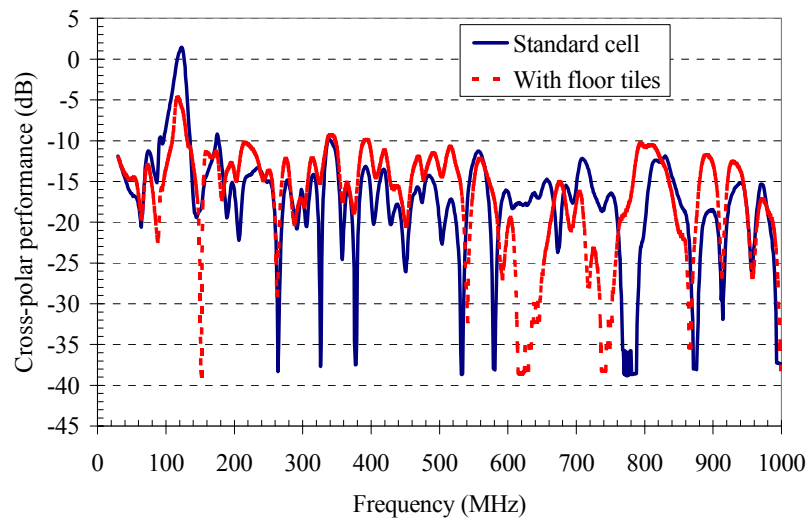

Figure 7: Effect of ferrite tiles on cross-polar performance of GTEM 1750.

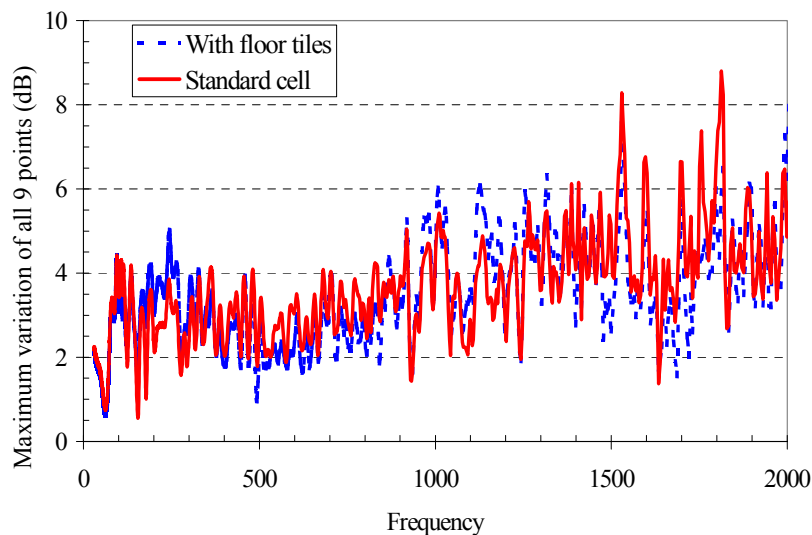

Figure 8: Field uniformity for 9-point grid

Figure 8 shows the field uniformity in the cell on a 9-point grid, covering an area of 583 mm by 583 mm (from [8]). The tiles have reduced the field at the points nearest the floor, and this reduces the field uniformity slightly at around 250 MHz. There was no significant change in

the input impedance to the cell. Using a small number of ferrite tiles on the floor provides a simple way of improving the cross-polar performance of the GTEM 1750.

3.2.5 Alternative method for field uniformity test

It is possible to test the field uniformity of a TEM cell with a much simpler measurement setup than described above. However, this alternative method is not described in IEC 61000-4-20.

As shown in [9] and applied in [10] reciprocity is valid, and known radiating sources, with known radiated E-field strength, can be used instead of field sensors. These sources can be battery powered and hence do not need any connection to equipment outside the cell. The radiating sources are placed at the calibration points in the cell and the radiation is detected at the GTEM port with a spectrum analyser. Therefore, the measurement setup is the same as for the emission measurements shown in Figure 14.

For the results presented here two different radiating sources were used. A CNE III radiating from 30 MHz to 2 GHz, and a CNE VII radiating from 1.5 to 7 GHz. The cross-polarisation inherent to both CNEs had previously been tested in a fully anechoic room, and found to be low. For the CNE III the cross-polar field components were in the noise floor of the measurement, and for the CNE VII the difference between the co-polar and the cross-polar components was more than 20 dB. The CNE III has a height of 17 cm and the CNE VII is 15 cm high.

According to IEC 61000-4-20, 12 of 16 points or 9 of 12 points have to be within -0 dB to $+6$ dB of the nominal field strength value. Since no nominal value is given in the test setup used here, the maximum difference between the calibration points was calculated for each frequency.

In Figure 9 this difference is shown for 12 points of the 16-point 1.5 m by 1.5 m grid. It can be seen that it does not stay within the 6 dB limit. But considering the size of the grid compared to the size of the GTEM cell, the field uniformity is better than expected.

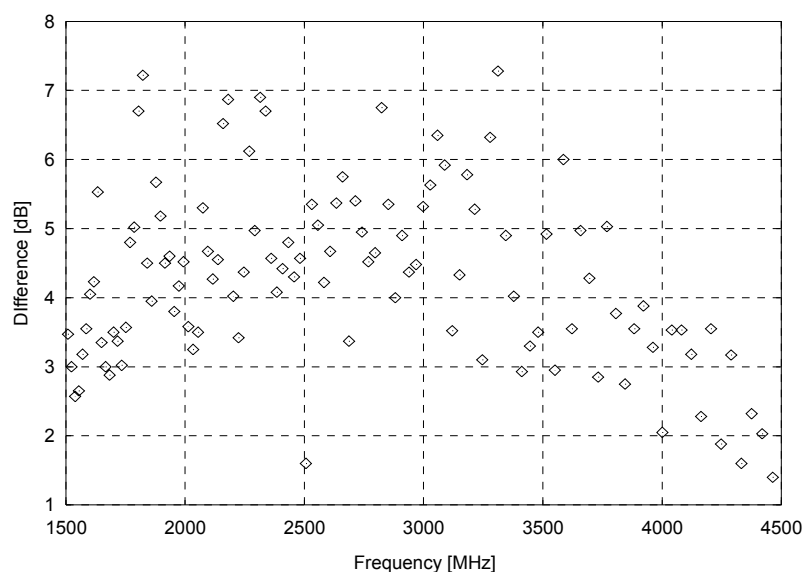

Figure 9: Maximum difference from 12 of 16 points

The 12-point grid is still 1.5 m wide, but only 1 m high. The field strength difference for 9 of the 12 points is shown in Figure 10. It stays within the 6 dB limit for most of the frequencies. No obvious frequency limit for field uniformity could be found in this experiment.

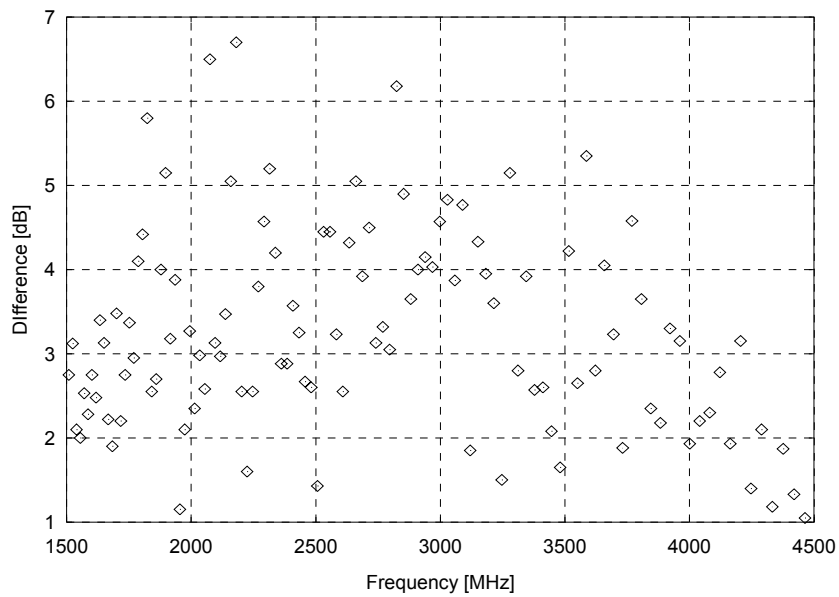

Figure 10: Maximum difference from 9 of 12 points

3.2.6 Using the alternative method to investigate cross-polar coupling

The CNEs were placed at each point of the different uniformity grids. But only the results for some grid points are presented here.

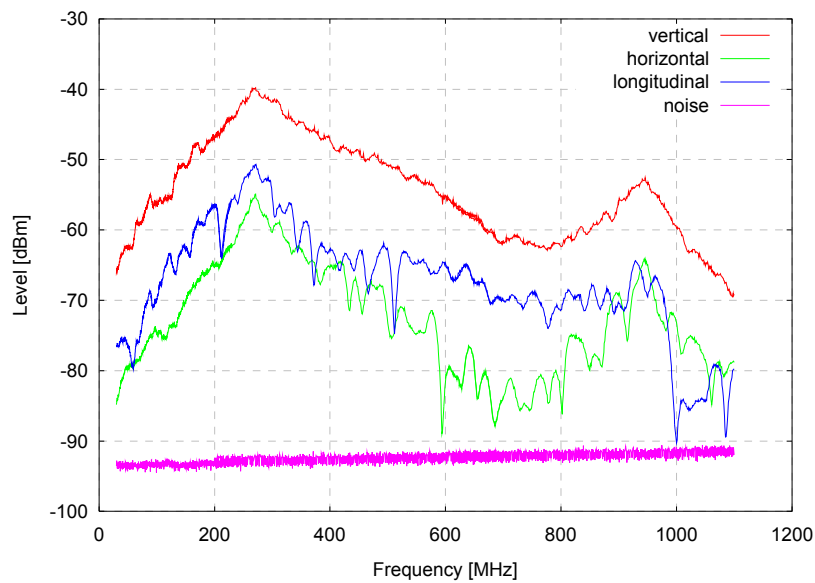

Figure 11: Field components in a top corner of the nine-point grid

Figure 11 shows the field components achieved with the CNE III between 30 MHz and 1.1 GHz. The location in the GTEM is at a corner point of the 9-point grid, at a height of 1.25 m and horizontally 0.5 m from the centre of the GTEM cell. The septum height at this location is 1.6 m.

The difference between the primary and the secondary field components is well above the 6 dB required across the full frequency range, despite the measurement location being fairly close to the septum.

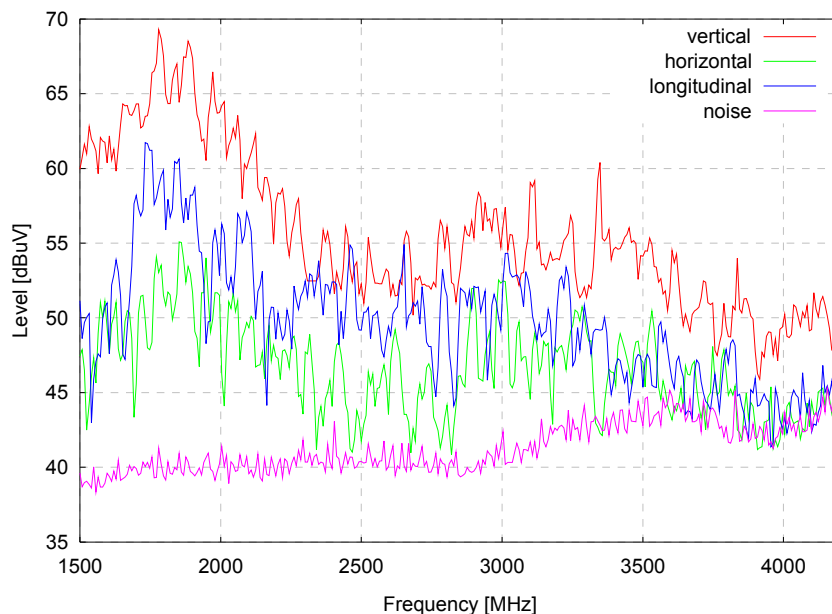

Figure 12: Field components in a central point of the 16-point grid

Figure 12 shows results of the CNE VII between 1.5 GHz and 4.2 GHz. The location is at a central point of the 16-point grid, at a height of 0.53 m and horizontally 0.25 m from the centre of the cell. Up to 2.3 GHz the differences between the vertical and the cross-polar field components are within the required specification. At higher frequencies the longitudinal component can become even larger than the vertical component.

Moving closer to the septum of the GTEM cell, this becomes even more obvious. In Figure 13 the differences between the primary and each secondary field component are shown for a location close to the septum. Here, the difference between the vertical and the longitudinal component is rarely above the required 6 dB, and from 2.3 GHz it even becomes negative, with the longitudinal component being larger than the vertical. Looking at these results however, it has to be kept in mind that a high longitudinal component is to be expected near the GTEM septum

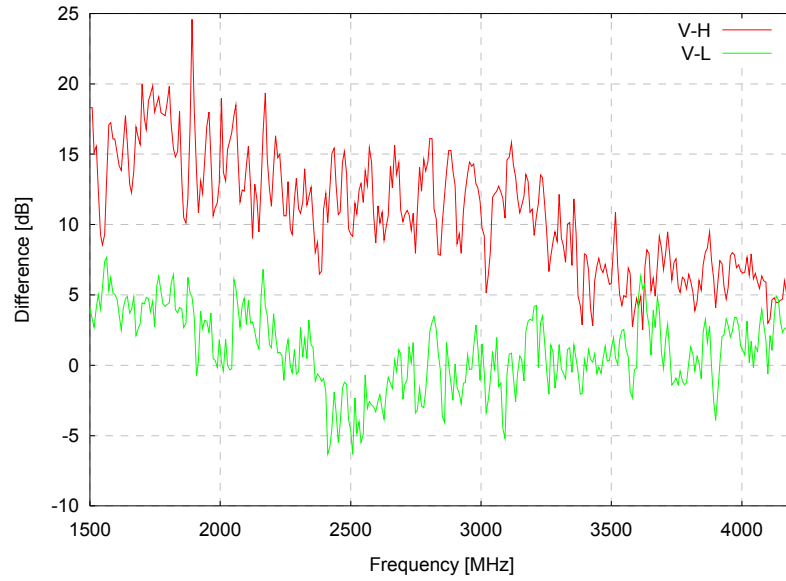

Figure 13: Difference of field components in a top point of the 16-point grid

More tests in different GTEM cells are required to verify the frequency limit at 2.3 GHz (or equivalent frequency for other size cells) that is suggested by the initial results presented here.

4 Emission measurements

According to CISPR 22 [11], the standard environment for radiated emission tests between 30 MHz and 1 GHz is the Open Area Test Site (OATS) with 10 m separation between the receiving antenna and the EUT (a 3 m separation is also allowed). In most cases, the results from alternative test methods have to be correlated to the OATS.

The concept of emission measurements in a GTEM cell is simple, since only the cell and a receiver are required. In order to correlate the results to an OATS, a set of at least three measurements and some computational post processing of the results are required.

In this section, the general measurement setup and the three orientations of the EUT inside the cell are described. The theory of the correlation is given in detail in [12] and abbreviated in [1]. Some typical results for GTEM to OATS correlations are also presented here, and an attempt is made to determine the upper frequency range up to which this correlation is valid.

4.1 Measurement setup

The setup for emission measurements in a GTEM cell is shown in Figure 14. The EUT is placed inside the GTEM and its radiation is measured with a receiver. This is typically a spectrum analyser. The receiver can be software controlled, and some software that includes the GTEM to OATS correlation is commercially available.

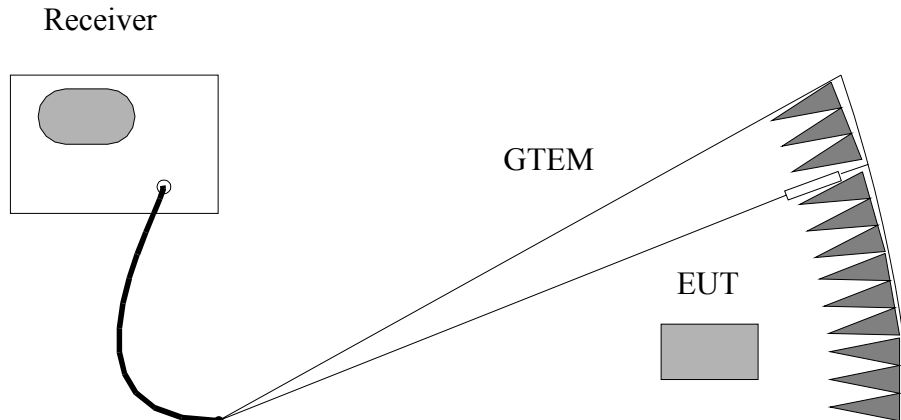

Figure 14: Emission measurement setup

4.2 GTEM to OATS correlation

The detailed correlation theory can be found in [12]. Apart from the generally used “three orientation method”, a more accurate “nine orientation method” is included there. This latter, requires, as the name suggests, up to nine different orientations of the EUT inside the GTEM cell, but is not so widely used because it is more time consuming. For the “three-orientation method” the main equation is given below. Other correlation methods are mentioned in [1], but the “three orientation method” is the one used in IEC 61000-4-20.

The following equation is used to calculate the maximum radiated electric field strength over an ideal ground plane:

$$|E|_{\max} = 20 \log \left| \frac{60k_0}{e_{0,y}} \right| + 10 \log \left[\frac{1}{Z_c} \sum_{\alpha=x,y,z} 10^{\frac{V_{m\alpha}}{10}} \right] + 20 \log(g_{\max})$$

In this equation, $e_{0,y}$ is the normalized vertical electric field of the TEM mode inside the GTEM cell determined with the following Equation:

$$e_{0,y} = \frac{2}{a} \sqrt{Z_c} \sum_{m=1,3,5}^{\infty} \left[\frac{\cosh(My)}{\sinh(Mb)} \right] \cos(Mx) \sin(Ma) J_0(Mg) \quad M = \frac{m\pi}{2a}$$

where Z_c is the characteristic impedance of the cell, J_0 is a Bessel function and a , b , g are given by the geometry of the GTEM cell, where $2a$ is the width of the cell, b is the septum height, and g is the gap between the septum and the side wall of the cell. It is calculated from the geometry of the GTEM at the EUT position. The factor g_{\max} can be calculated from the geometry of the EUT and the antenna on the OATS, and $V_{m\alpha}$ are the voltages in $dB\mu V$ measured at the output port of the GTEM cell for the three orientations of the EUT inside the cell. Factors such as cable loss and the frequency response of the receiver also need to be taken into account.

The three orientations of the EUT have to be orthogonal to each other so that each axis of a co-ordinate system of the EUT is aligned in turn with the vertical axis of the cell. This can be realised in the following way: The cell is given a co-ordinate system (x,y,z) where the z-axis is the direction of wave propagation (the longitudinal axis), the y-axis is vertical and therefore aligned with the electric field strength, and the x-axis is horizontal and aligned with the magnetic field. The EUT is now given a “primed” coordinate system (x',y',z') and, for the first orientation, this is aligned with the co-ordinate system of the cell. For the other two orientations, the x'-axis and the z'-axis are in turn aligned with the y-axis of the GTEM, as shown in Figure 15. For a real EUT, these orientations would appear as shown in Figure 16.

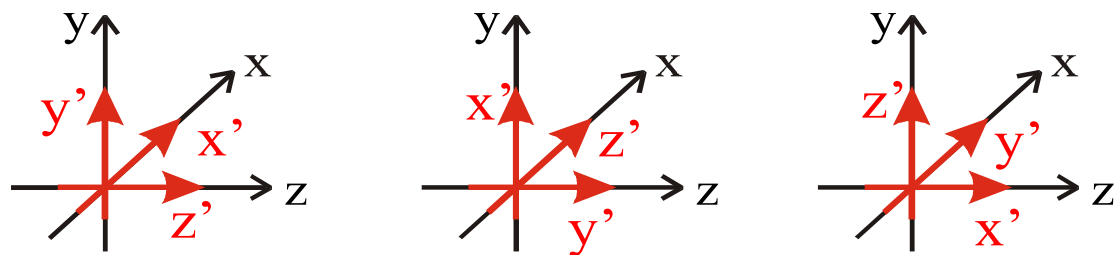

Figure 15: Coordinate systems for the three orientations of the EUT inside the GTEM

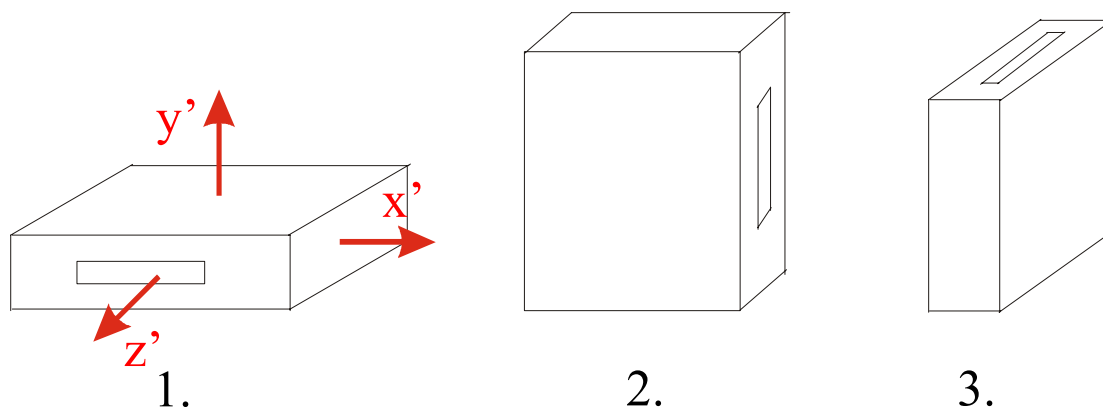

Figure 16: The three orientations of an EUT

4.3 Typical correlation results

The measurements presented in this section were performed in two different GTEM cells and on two different open area test sites, using the same EUTs as described below, one acting as a radiator and one designed for immunity testing. Only a subset of measurement results are presented in this Guide, the full set is in the Final Report [1].

4.3.1 The EUTs

The REUTE (Representative EUT for Emissions) comprises a brass enclosure with a removable lid and side panel, and an emitter. The dimensions are 48 x 48 x 12 cm. Both lid and side panel also have slots, which may be open or covered. The lid and side panel may also be held away from the body of the box by plastic panels, which provide insulation between the covers and body, thus forming a gap through which field can radiate. They are held in place with metal screws as required. The side panel with its slot is shown in Figure 17. The REUTE is battery powered to allow any cables to be attached as and when required.



Figure 17: Representative EUT showing battery (top left), 7 GHz CNE (top centre), 2 GHz CNE (top right)

The REUTE is based around the use of two Comparison Noise Emitters (CNEs), which are selected via an external switch. These two CNEs operate over different frequency ranges. The lower frequency unit (30 MHz to 2 GHz) is connected to a metal rod, which runs around the inside of the enclosure and is terminated on the inner conductor of a panel mounted bnc connector. Many resonant modes within the enclosure are excited and also an external cable can be excited directly for maximum radiated emissions. The 1.5 GHz to 7 GHz CNE drives a small (1.5 cm) antenna. The block of carbon loaded absorber is included to reduce the quality factor (Q) of resonance within the enclosure.

4.3.2 The test sites

4.3.2.1 The GTEM cells

At the YES Castleford EMC Test Laboratory the emissions measurements were carried out in an EMCO 5311 GTEM cell using an Anritsu spectrum analyser, model MS 2663B.

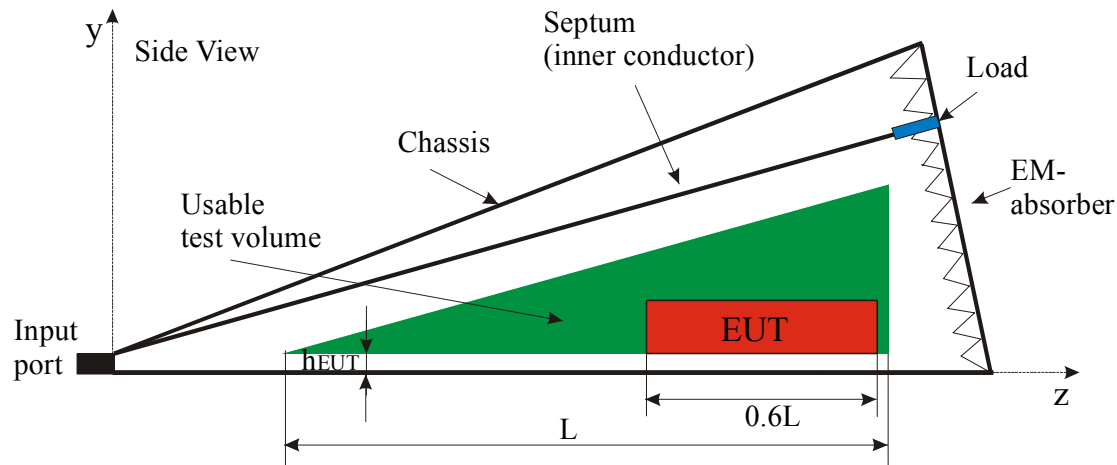

Figure 18: GTEM Cell Side View

At NPL, the instruments used were a Marconi spectrum analyser, MI2383, connected to the GTEM cell with a screened cable, and a computer to read the data from the analyser. The GTEM cell used at NPL is an MEB GTEM 1750. At the absorber end, this cell has a septum height of 1.75 m. The measurements with the CNEs and the REUTE were performed at a septum height of 1.6 m at the centre of the EUT.

4.3.2.2 The Open Area Test Sites

NPL has an uncovered outdoor ground plane of dimensions 60 m x 30 m. It is a continuously welded steel plate with a flatness of ± 5 mm over 95% of its area. It is ensured that unwanted reflections from antenna supports, trees and buildings give an insignificant contribution to the result. Agreement between calculated and measured coupling between a pair of resonant dipole antennas shows that the uncertainty caused by the ground plane is less than ± 0.05 dB. It therefore very close to the ideal ground plane for the frequency range 30 MHz to 1 GHz.



Figure 19: EUT measurement at 10 m range on short axis of NPL 60 m ground plane

The OATS measurements were performed for 3 m and 10 m separation between the EUT and the receiving antenna. The receiving antenna was scanned between 1 m and 4 m height, and the EUT was placed at 0.8 m height and rotated at approximately 2° per second. Three continuous height scans were performed during a full 360° rotation. This method differs from the conventional method of doing a full height scan at each azimuth angle, but the same method was used at both NPL and York for the measurement of the REUTE as a compromise between measurement accuracy and time taken. It is possible that the maximum levels of some radiation pattern lobes were not measured, especially at the higher frequencies (eg above 400 MHz).

The MI2383 spectrum analyser was used with the same settings as for the GTEM measurements. This was necessary for the GTEM to OATS comparison. The receiving antennas were a bilog up to 2 GHz and a ridged waveguide horn antenna above 1.5 GHz. The measurements were performed for both horizontal and vertical polarisation of the receiving antenna. For some measurements an amplifier was used to enhance the received signal. The frequency response of this amplifier was measured and subtracted from the results in the post processing.

The REUTE was operated in the same configurations, with and without attached cable, as for the GTEM measurements.

For the OATS measurements at YES, the EUT was placed on the top of a table of height 80 cm inside a fibreglass hut, see Figure 22. The distance between the antenna and the centre of the EUT was set to 10 m. Emission measurements were performed with the table rotating and the mast scanning from 1 m to 4 m high, with peak hold function selected on the spectrum analyser.



Figure 20: OATS at YES Castleford EMC Test Laboratory with the metallic ground plane, the mast and turning table.

4.3.3 Results for the CNE III

The GTEM measurements used for this correlation were performed at a septum height of 1.56 m, and the centre of the CNE was at a height of 75 cm above the GTEM floor. On the OATS the CNE was 80 cm above the ground and rotated about its vertical axis. The distance to the receiving antenna was 3 m or 10 m, and the antenna was scanned from 1 m to 4 m height. The antenna was first horizontally polarised and then vertically polarised, and for each frequency the higher of the two received signals was compared to the equivalent GTEM result. For both the GTEM and the OATS measurement, the MI2383 spectrum analyser was set to a video bandwidth of 25 kHz and a resolution bandwidth of 300 kHz. For the CNE III, the correlation was performed from 30 MHz to 1100 MHz.

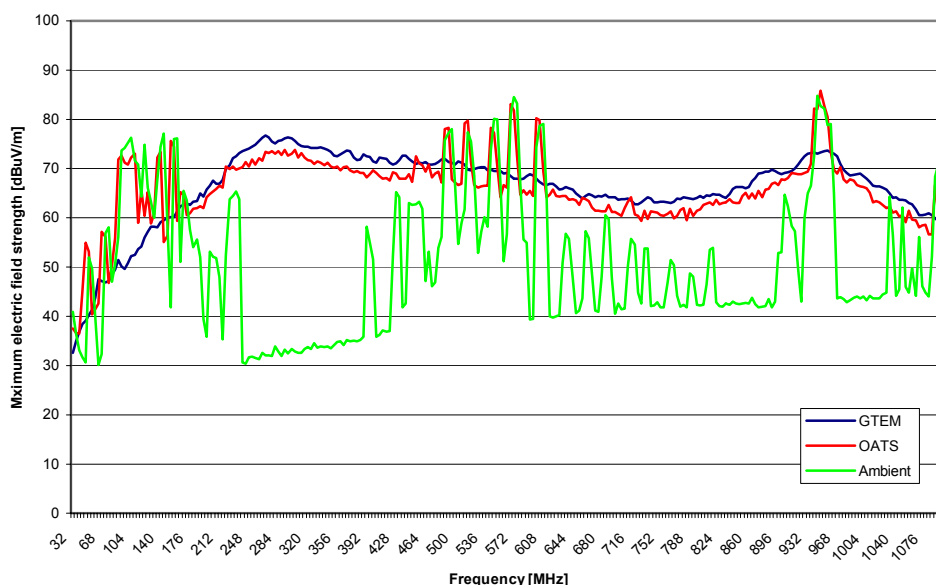

Figure 21: GTEM to 10 m OATS comparison for CNE III

Figure 21 shows the CNE III results for an antenna separation of 10 m. The RF ambient interference on the OATS is included to show that some peaks in the received signal are due to the ambient and not emitted by the CNE. Ignoring this ambient, the highest difference between the GTEM and the OATS results is around 8 dB on the 3 m OATS. For the 10 m OATS the correlation is much better, with a maximum difference of around 3 dB. In both cases, the GTEM results are higher than the OATS results.

On the 10 m OATS, the ambient is very high below 200 MHz, between 450 MHz and 600 MHz and around 900 MHz. Here the main advantage of the GTEM becomes obvious, as it can show the radiation of the CNE, where it is obscured on the OATS.

4.3.4 Results for the CNE VII

The CNE VII measurements in the GTEM cell were performed at a septum height of 1.62 m, and the centre of the CNE was at a height of 76 cm. The setup on the OATS and the analyser settings were the same as for the CNE III measurements. For the CNE VII, the correlation was performed from 1 GHz to 4.2 GHz.

Figure 22 shows the CNE VII results for an antenna separation of 10 m. As for the CNE III, the correlation for the 10 m OATS is much better than for the 3 m OATS. For the 10 m OATS, the plots diverge above 3.5 GHz. The ambient did not affect these measurements, since the radiation of the CNE VII is well above the ambient level.

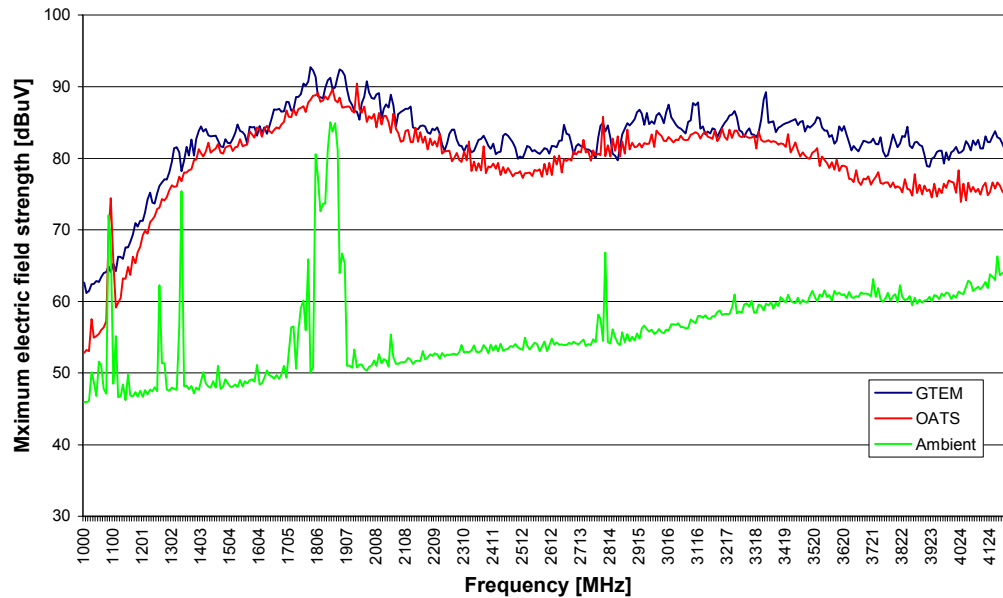

Figure 22: NPL GTEM to 10m OATS comparison for the CNE VII

4.3.5 Results for the REUTE up to 2 GHz

The REUTE measurements in the GTEM cell at NPL were performed at a septum height of 1.6 m, and the centre of the REUTE was at a height of 63 cm. The setup on the OATS and the analyser settings were the same as for the CNE III measurements with 10 m separation between the EUT and the receiving antenna. A pre-amplifier was used on some measurements to enhance the signal. In those cases, the amplification was subtracted from the signal in the post processing.

Due to removable lids and side panels with gaps and slots, which could be open or covered, different configurations of the REUTE were possible. Only the arrangement for maximum radiation, called the slot and gap mode, is presented here. More results can be found in the Final Report [1].

The REUTE was operated in two different frequency ranges. From 30 MHz to 2 GHz the CNE III source inside the REUTE was active, and from 1.5 GHz to 4.2 GHz the CNE VII source was used. The results up to 2 GHz are presented here, and results above 1.5 GHz are in Section 4.3.6. In the graphs below, GTEM and OATS emission levels are plotted for the maximum of either vertical or horizontal polarisation.

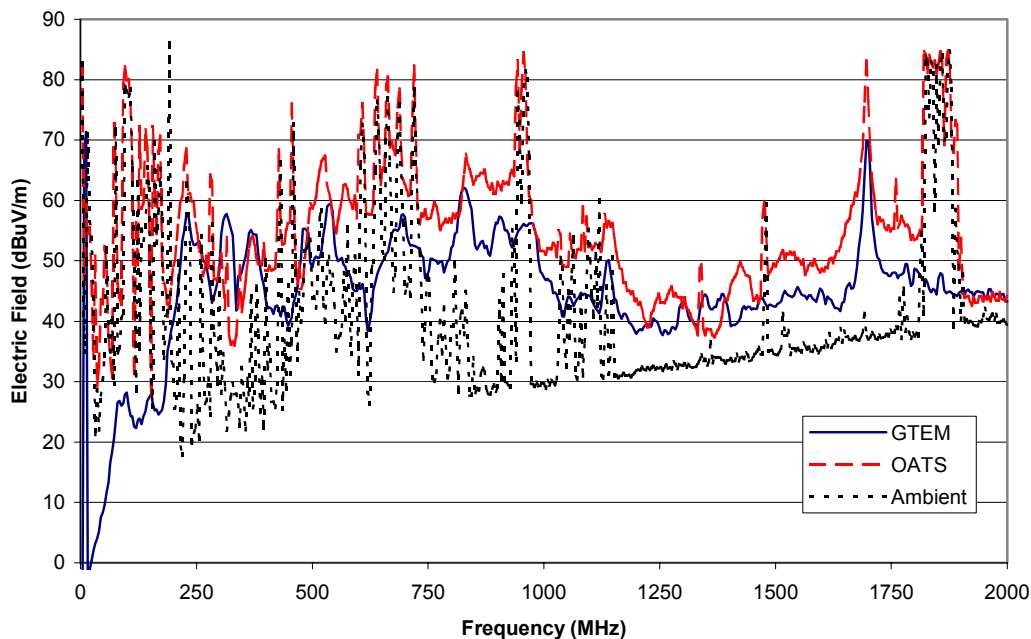

Figure 23: YES GTEM to 10m OATS comparison for the REUTE in the Slot and Gap Mode

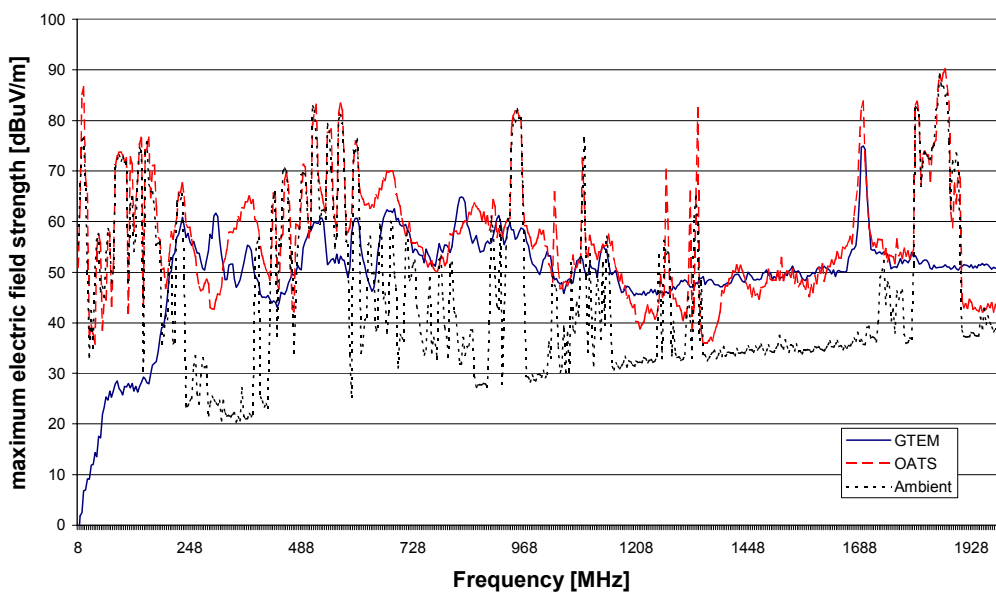

Figure 24: NPL GTEM to 10 m OATS comparison for the REUTE in slot and gap mode

Figure 23 shows a reasonable agreement between the OATS measurements and the GTEM data, despite the fact that the OATS data seems to be shifted up by 7 dB as an average displacement. This displacement can not be seen in Figure 24 where the agreement between GTEM and OATS results is very good. However, below 2 GHz the REUTE signal is not far above the ambient, making the comparison difficult.

4.3.6 Results for the REUTE from 1.5 GHz up to 6 GHz

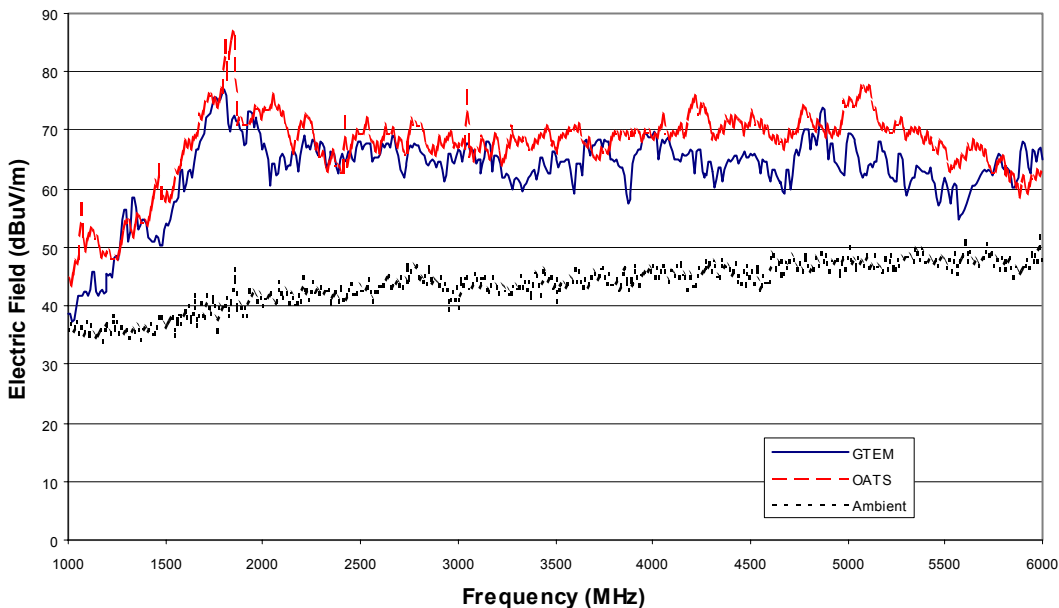

Figure 25: YES GTEM to 10m OATS comparison for the REUTE in the Slot and Gap Mode

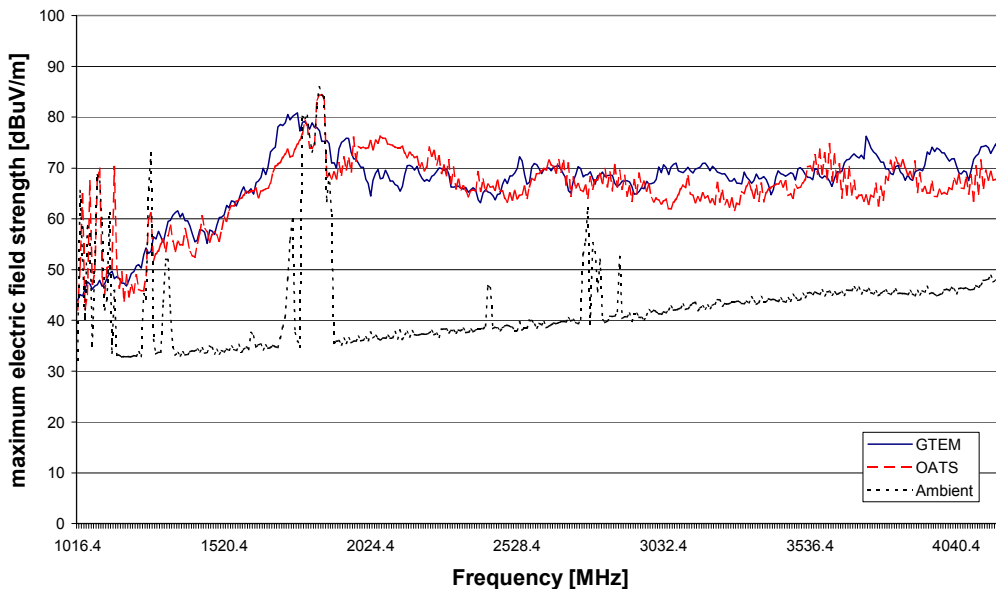

Figure 26: NPL GTEM to 10 m OATS comparison for the REUTE in slot and gap mode

Figure 25 shows the YES comparison for frequencies up to 6 GHz. A good agreement is obtained over most of the frequency range, with a 5 dB difference between the GTEM and OATS for frequencies above 4.5 GHz.

The main difference between the NPL and the YES results is that the NPL GTEM “OATS correlated” result is generally higher than the actual OATS result, where for YES it is often lower. To further investigate this difference, the REUTE was also tested in a third GTEM at EMC-Hire Ltd. The results are compared in the next section.

4.4 Comparison of results from three different GTEM cells

In this section results from above are re-presented, but with YES and NPL plots on the same graph. The measurements in a GTEM cell were also performed by a third test laboratory, EMC-Hire Ltd, using an EMCO GTEM cell with a maximum septum height of 1.1 m. These third results are included in the graphs with the correlated GTEM results.

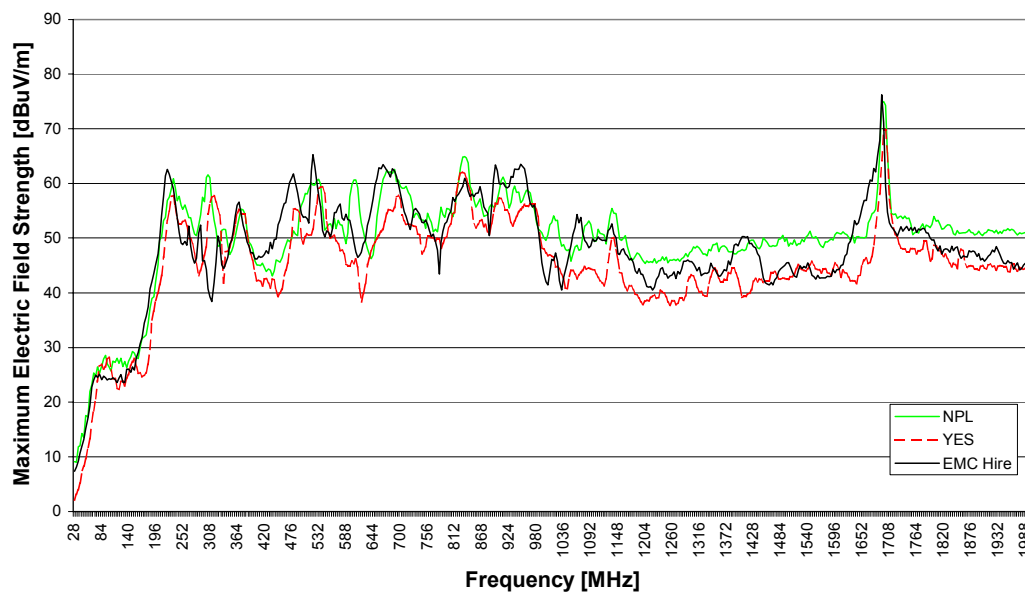

Figure 27: REUTE in slot and gap mode up to 2 GHz in different GTEM cells.

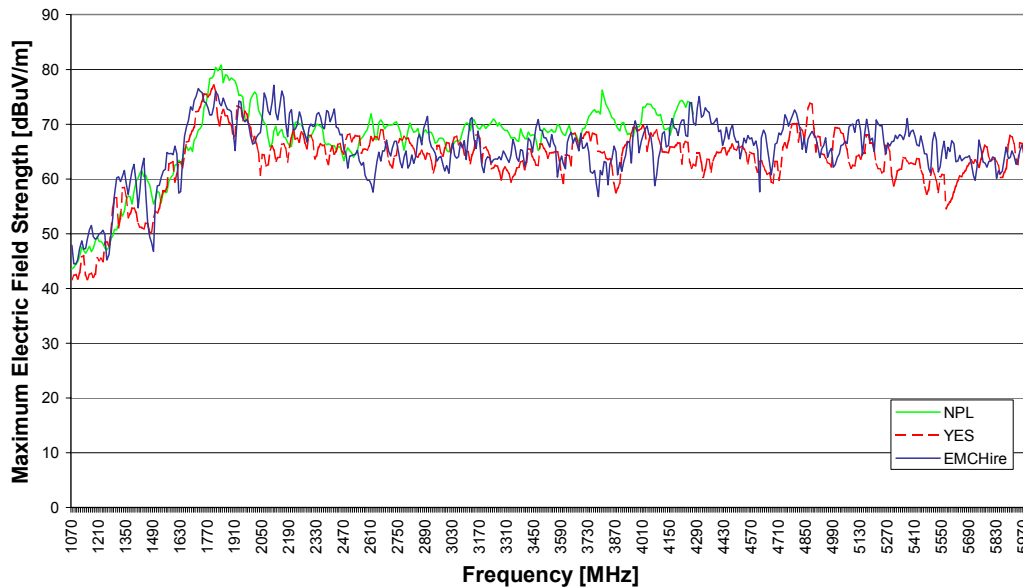

Figure 28: REUTE in slot and gap mode above 2 GHz in different GTEM cells.

In general there is good agreement between the YES and NPL 10 m OATS results. However, for the GTEM cell there is a noticeable trend of the YES results being 5 dB to 10 dB higher than the equivalent NPL result. The reason for this is not understood at this stage, and it is recommended that the REUTE be measured by other laboratories in a wider round-robin exercise. So far only one additional laboratory, EMC Hire, was able to perform the measurements.

The NPL GTEM cell was larger, having 1.75 m maximum septum height, against the YES and EMC Hire maximum of 1.1 m. However this should not cause a significant difference because the equivalent radiated field from a GTEM cell takes the septum height into account. The results from EMC Hire lie between the NPL and the YES results in most cases, their cell being the same make and size as the one used by YES.

4.5 Sources for measurement uncertainties

4.5.1 Effect of repositioning the REUTE in the GTEM

Measurements were performed over both frequency ranges of the CNEs to test reproducibility of positioning. For each measurement, the REUTE was repositioned at the same location with an uncertainty of 5 mm in the relocation. The full data set can be found in the Final Report [1] and is summarised as follows: over the frequency range 30 MHz to 2000 MHz, an average variation of 2.10 dB was obtained over 10 consecutive measurements when comparing each frequency value for each measurement. The maximum difference observed was 3.91 dB. Over the frequency range 1 GHz to 6 GHz, an average variation of 1.96 dB was obtained over 10 consecutive measurements when comparing each frequency value for each measurement. The maximum difference observed was 4.2 dB.

4.5.2 Effect of linear displacement

The effect of linear displacement was studied up to 6 GHz over all three axes. Measurements of the REUTE's displacement over the x-axis were performed over a distance of 10 cm with an increment of 1 cm.

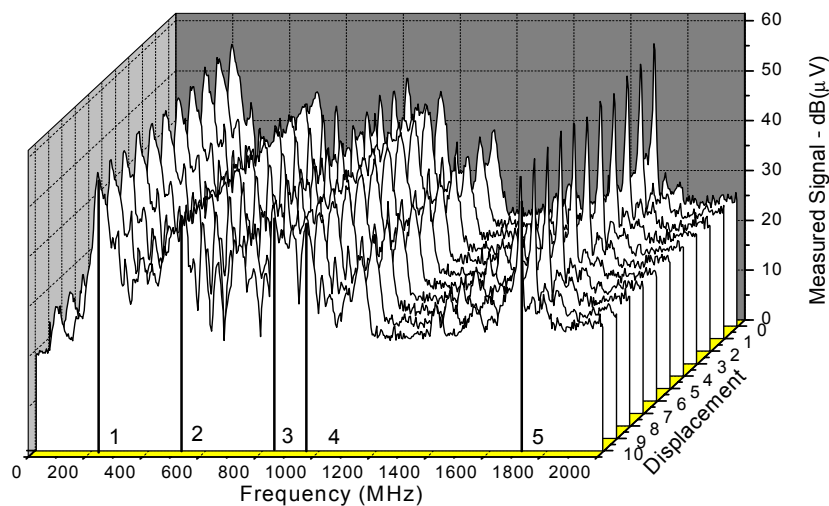

Figure 29 Emission measurement of REUTE as function of displacement for the x-axis up to 2 GHz

Figure 29 shows the response of the REUTE in the GTEM as a function of the displacement for frequencies up to 2 GHz. In Figure 30, the maximum emissions as a function of displacement are plotted for comparison: a maximum variation of 4.7 dB with a typical average variation of 2.8 dB has been measured for this frequency range. For indication, the numbers (1,2,3,4 and 5) in Figure 29 correspond to the points in the legend of Figure 30.

Measurements of the REUTE's displacement over the y-axis were performed over a distance of 100 cm with an increment of 12.5 cm. Firstly, the REUTE was positioned directly onto the floor of the GTEM cell and then raised from the floor by using polystyrene foam of 12.5 cm thickness. A 12.5 cm increment was chosen to investigate the effect of large displacement when placing styrene under the EUT. The REUTE was centred over the x-axis (directly facing the measurement port) and positioned at a location where the septum height was 108 cm.

Measurements of the REUTE's displacement over the z-axis were performed over a distance of 10 cm with an increment of 1 cm, similar to those performed for the x-axis.

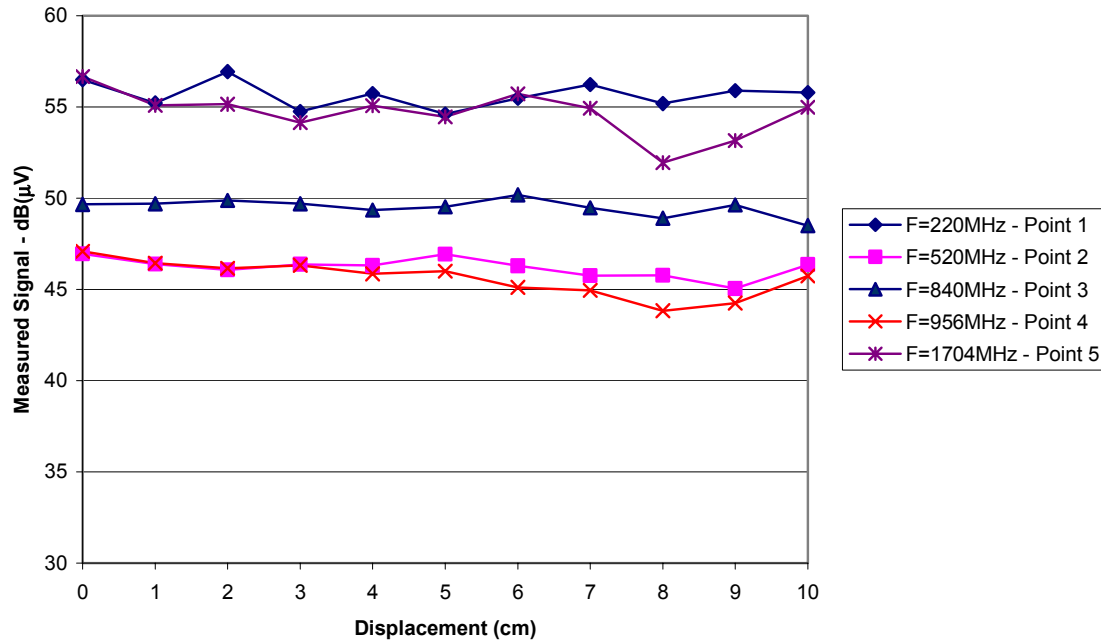

Figure 30: Variation of peak level of emission as function of displacement for the x-axis

Graphs for the results of the displacement over the y-axis and the z-axis are included in the Final Report [1] and a table summarising the results is shown below.

Frequency	30 MHz to 2 GHz		Frequency: 1 GHz to 6 GHz	
	Average (dB)	Max. (dB)	Average (dB)	Max. (dB)
Axis x over 10 cm	2.78	4.72	3.2	5.9
Axis Y over 100 cm	4.56	8.76	5.46	11
Axis Z over 10 cm	3.12	4.46	3.19	3.63

Table 2: Summary of the emission variation for the three axes for both frequency ranges

From Table 2, the variations in the emissions are slightly higher in the frequency range 1 GHz to 6 GHz. On average, the variations are less than 5 dB except for the y-axis where an increment of 12.5 cm was used for the measurement results.

5 Example uncertainty budget

There were variations of up to ± 10 dB on the measurements of the REUTE in GTEM cells by three organisations. Whilst this may appear to be excessive it should be viewed in the light of similar variations experienced between different OATS and the fact that the overwhelming uncertainties caused by ambient interference do not apply to GTEM cell measurements. Further work is required to refine measurement methods and intercomparisons are required to get more data.

An exercise to compare immunity measurements in a GTEM cell with those in a FAR showed very promising agreement, overcoming a fear that the presence of the metal walls of the GTEM cell may unduly influence the EUT.

Various components that can contribute to the measurement uncertainty are presented in the Table below; the magnitudes of uncertainty have been included by way of example. The following budget is based on the terminology used in CISPR 16-4 [13], which is similar to LAB34 [14].

Table 3: Example uncertainty budget for radiated field strength in a GTEM cell

Symbol	Source of Uncertainty	Value (dB)	Distribution	Divisor	U_i (y) \pm (dB)
R_{Cal}	Receiver Calibration Uncertainty	± 1.00	Normal (k=2)	2	0.50
R_{Lin}	Receiver Linearity	± 0.10	Rectangular	$\sqrt{3}$	0.06
R_I	Receiver Indication Resolution	± 0.05	Rectangular	$\sqrt{3}$	0.03
R_{Freq}	Receiver Frequency Error	± 0.10	Rectangular	$\sqrt{3}$	0.06
R_{Drift}	Receiver Drift	± 0.20	Normal (k=1)	1	0.20
M	Mismatch (GTEM to Receiver)	± 0.25	U-shaped	$\sqrt{2}$	0.18
C_L	Cable loss uncertainty	± 0.02	Rectangular	$\sqrt{3}$	0.01
G_{Uni}	Field Uniformity in Test Area	± 3.00	Normal (k=2)	2	1.50
$G_{Response}$	GTEM Deviation from Flat Frequency Response	± 2.00	Normal (k=2)	2	1.00
G_{Cross}	Cross-Polar Coupling, Higher Order Modes	± 1.00	Rectangular	$\sqrt{3}$	0.58
G_{Height}	Septum Height Variation Over EUT Location	± 0.50	Rectangular	$\sqrt{3}$	0.29
G_{Z0}	GTEM Characteristic Impedance	± 0.18	Rectangular	$\sqrt{3}$	0.10
G_{Corr}	GTEM - OATS Correlation	± 1.00	Normal (k=1)	1	1.00
R_{EUT}	EUT Repeatability	± 2.00	Normal (k=1)	1	2.00
u_c (y)	Combined Standard Uncertainty		Normal (k=1)		± 3.0
U (y)	Expanded Uncertainty		Normal (k=2)		± 6.0

Notes: u_i (y) is the standard uncertainty of the i^{th} term. The expanded uncertainty is based on a standard uncertainty multiplied by a coverage factor of k=2, providing a level of confidence of approximately 95%.

6 Hints and tips

6.1 Saves on building space

The GTEM is a compact cell that leaves lots of space around the tapered end of the cell. This is very useful for standing amplifiers and other test gear. In particular the cell will fit into some factory spaces without the need to rebuild the roof. The largest EMCO 1750 cell is 3.08 m high, which can fit into spaces without having to raise the roof. However, it is possible to lower the cell by 120 mm by reducing the height of the legs above the castors. Some cells have been built into rooms with the highest absorber end penetrating the suspended ceiling.

6.2 You can move it

Although a 1750 cell can weigh 1.2 tonne it can still be moved around easily on its castors. This is very useful if the cell is assembled on site in the middle of the room (you need access all round during construction) and it can then be pushed up to a wall. However the floor does need to be flat within 6 mm, so that the panels of the cell do not twist and stress the joints. You do need to be careful that the nylon bolts, which project from the septum suspension, do not catch on any projections from the wall or ceiling when you move it.

6.3 It is screened

The cell is screened using finger strips on all the panels and a knife-edge seal on the door. This makes the cell more like a screened room in contrast to conventional strip lines etc. This not only enables use for low-level emission measurements but also avoids interference with other equipment in the laboratory when doing high-level immunity measurements.

6.4 Low level dynamic range

Low-level measurements are possible in the cell at much lower field strengths than can be achieved on an OATS (or in a FAR) below about 80 MHz. This is because the transmission line has a flat frequency response whereas the OATS measurement becomes more inefficient at low frequencies because the antennas become short dipoles.

6.5 It has its own fan, but this can present a noise problem.

The internal load for the transmission line is rated to be 1 kW on the 1750 cell so it is possible to raise fields of 125 V/m or more if the EUT is moved towards the apex. (or over 200 V/m in an 1100 cell). However this does require good ventilation from the inbuilt fans. These fans are not required as the power is reduced towards 100 W and convection cooling is adequate. This is important if you have a product that is sensitive to noise or vibration such as a sound level meter.

6.6 Earth currents – hum

The large ac supply filters under the cell draw a significant amount of earth leakage current. This is not normally a problem but it can cause hum loops in the connections to peripheral test equipment outside the cell. For example, if the cell is plugged into a separate supply on the wall, and the external monitoring equipment for the EUT is plugged into another branch or ring of the supply in the laboratory, it is quite likely that there will be a differential voltage between the GTEM chassis and the ground of the test gear. For certain sensitive measurements this can be a problem and can be easily cured by taking the test equipment mains supply from the outlet on the GTEM itself.

6.7 Windows

If the EUT has visual indicators, it is important to be able to observe them during an immunity test. A window can be provided in the door. Windows can be fitted in other positions to allow the equipment to be observed from different angles, possibly using cameras focused on the EUT. The windows have high RF attenuation so do not degrade the screening efficiency of the cell.

6.8 Penetration plate requirements

A penetration plate allows signal and power cables to pass from the inside to the outside of the GTEM cell. The type of penetration plate and its position is very important. Some users have them in the floor near the door but others have them under the EUT and others have plates in the side wall. It is important that the cables running in and out of the cell are properly decoupled as they leave the cell. This can be done with a screened connector properly fixed to the plate so that the screen of the cable is bonded to the chamber wall. Multi-core cables such as D Type or GPIB may require a special type of connector. Unusual connectors or unscreened cables should be run through an absorbing clamp close to the penetration plate hole – however the use of clamps is debatable, so study the Standard against which the measurements are being made. Smaller cables can be run through a “beyond cut-off” tube without bonding to the plate. Fibre optic and pneumatic tubes can be run through the hole provided they do not have metallic armouring – if they do, clip on ferrites should be placed on the armouring. The plate should be close to the EUT to avoid cables running along the Z axis. Most of the cable should be dressed along the Y axis and the rest along the X axis – see Section 6.21 regarding cable routing.

6.9 Protecting the RAM

When the RAM is delivered with the cell it may be protected by specially made inverse shaped polystyrene blocks. Do not discard these blocks – keep them fitted in use to protect the tips of the RAM from damage. They are transparent to RF.

6.10 Rotating the EUT

The EUT has to be rotated through 90 degrees (about the long axis of the cell) to simulate vertical and horizontal polarisation on each face (for immunity). However this means that the camera needs to move with it to stay fixed on the EUT display without getting the camera supports into some impossible positions. This can easily be overcome without buying a

manipulator. A flat plate support can be constructed using low loss board and various Velcro straps. This enables the support plate to be fixed onto the EUT with the straps and the camera, which also has self adhesive Velcro covering, can be stuck onto the plate in whatever position best suits the focus of the camera. It helps to have a sheet of tacky plastic between the camera plate and the EUT to stop it twisting.

6.11 Observing the EUT display

Small CCTV cameras are available that are RF hardened by being constructed in a metal box with filtered connections. The big weakness is the connections. The video cable must be a Fibre Optic Link and the supply cable cannot be a conducting cable – this alters the field uniformity in the vicinity of the cable. To overcome the power problem make use of more Velcro to stick a rechargeable battery on the side of the camera and make up a short connecting cable between camera and battery. This makes a fairly non-invasive package and can give 8 hours use on the battery whilst another one is on charge.

6.12 Choosing the amplifier

The amplifier needs to deliver enough power to raise the necessary field strength. But remember that this has to be nearly 4 times the power that is needed for the unmodulated signal once the amplitude modulation is switched on.

Drift is also a problem when an amplifier warms up. Check it has sufficient warm up time and that it will not run out of steam when it has been on all day. This will help ensure that level adjustments need the minimum of iterations when the software is subsequently trying to re-establish a particular power level. This all saves time on each test run.

Distortion is another problem – harmonics can upset the accuracy of the voltage or power monitoring – see later. They also can subject the EUT to higher frequency stimulus than that selected which can give misleading results. A failure of an EUT immunity test may not be due to the fundamental frequency but to its harmonic frequency. Harmonics at real output power levels should be at least 15 dB below the carrier (see IEC 61000-4-3 [3]).

6.13 Choosing the power sensor

Not all voltage and power measuring sensors work the same and they do not respond to RF harmonic errors to the same extent. Diode detectors will measure the error as a change in the peak voltage and produce a larger inaccuracy than thermocouple sensors, which respond to the heating effect due to the area of the waveform. However if the diode detector input is low enough it will change into a square law characteristic and give similar results to the thermocouple. This can be summarised as follows:

Thermocouple Detectors (or Diode Detectors below -20 dBm) :

-15°dBc Harmonics cause +9% power error

which equals +3%V/m error or +0.3 dB error

Diode detectors above -20 dBm:

Fundamental Level dBm	Level error dBm		
	Caused by harmonic level of dBc		
	-20	-15	-10
0	-0.7/+0.8	-0.6/+1.9	-1.2/+2.7
-10	-0.5/+0.7	+0.1/+1.7	-0.3/+2.4
-20	-0.1/+0.4	+0.4/+1.4	+0.5/+1.7

6.14 Connect susceptible test equipment outside the cell

Remember that the test equipment you have may be more susceptible than your EUT and it needs to be outside the cell. This may not be adequate if the RF stress frequency gets onto the inner conductors of the interconnecting cables. Remember then that these inner conductors will need filtering (possibly at the input to the test gear) to lower the RF to below the test gear threshold of immunity without affecting the specified load on the EUT

6.15 What is the turntable made of

The material of the table or turntable in the cell can affect the field strength and uniformity. Resin in the wood has a high permittivity that can affect the field in the cell. A test of the table material can be made by doing a field calibration with and without the table in the cell. Such tests have found that a wooden table can produce an error of several decibels at around 700 MHz for example. So what should you use? Polystyrene is about as transparent as you can get, but a load spreader is required to avoid damage to the foam. Several high density plastics are nearly as good and Delrin gives good results in general, depending on the bulk. A few experiments will soon identify the best balance between RF performance and mechanical strength.

6.16 Putting light in the cell

To see what the EUT is doing during immunity testing requires a source of light – particularly if it has a display that is not back-lit. Conventional metal-framed lamps are not suitable because they distort the field contours as a result of their construction or their power cable. This is particularly true if the light has to be manipulated into a special angle to illuminate a liquid crystal for example. A solution to this problem can be found with fibre optic technology. A robust fibre optic light pipe will carry 150W of light from a projector outside the cell, through the penetration plate and can be positioned anywhere inside without upsetting the field – provided you make sure the fibre cable is armoured with plastic and not a metal spiral.

6.17 Cleaning the door

Many doors have a brass surround that tarnishes with time. It is very hard work to clean this surface without restricted solvents so leave it alone. The only important connection is the mating faces of the knife-edge door seal. These rely on abrasion during closing to keep them clean. The door can catch you by surprise if you are not aware that it tends to swing open. The stay fitted to the door will control the speed of opening but it tends to swing open because the hinge is not vertical due to the geometry of the cell.

6.18 Incline the table

The cell depends on the tapered construction to achieve the relatively mode free performance. However, since the floor of the cell is horizontal this means that the centre line of the axis half way between the septum and the floor is inclined to the apex at an angle of about 6°. In order to present the face of the EUT at a tangent to the approaching wavefront this means that the surface of the table or turntable should be tilted an appropriate amount.

6.19 Remote actuation

Some companies make actuators for use in the cell but these may not be made of materials that are not invasive at high frequencies. Ask to see test results of field uniformity with and without the actuator in the empty cell. The actuator may not give the most appropriate cable routing around its pivot. Does it minimise the length of cable in the Z axis? Sometimes there is a need for a small actuator to press buttons. This can be done with plastic rods and pieces of string (!) but otherwise the general precautions regarding materials and control cables apply.

6.20 Coping with liquids

You cannot turn the EUT on its side if it contains liquids in an open container. In this case you need to review the design with the client to see how the correct operation of the EUT can be simulated in some attitudes without liquids. Alternatively, it may be possible to detach the container and rotate the electronics package alone

6.21 How to route cables

This is probably the most contentious issue in the EMC world and it is by no means a problem that is restricted to the GTEM cell. However, because the cell is compact, the relative dimensions of interconnecting cables soon become an issue. Cables pickup can ruin the performance of an otherwise good EUT and make a lot of difference to the immunity of the test item at lower frequencies – below 150 MHz where the cables can act as resonant antennas. Because of the existence of a longitudinal field component in the GTEM, it is important that cables are not routed inside the cell along the longitudinal axis. To get from the boundary of the EUT the cable should be routed along the transverse (X) axis or diagonally towards the penetration plate. This will avoid over-testing the EUT.

6.22 How to terminate cables

Cables that are connected between the EUT and peripheral equipment outside the cell are grounded at the penetration plate, which is normally in the floor. These cables will most likely go into a high Q resonance due to their length and slenderness ratio. If such a cable is a single screened coaxial cable for example, the current flowing in the braid will couple into the inner conductor and may cause unacceptable susceptibility of the EUT. Such resonances are undesirable for other reasons however because the distortion of the field around the cable will alter the normal coupling mechanism between the cable and the EUT and its other cables which ideally would be immersed in a uniform field test environment. The influence of cables on the test result requires careful consideration – for current practice refer to the Basic EMC standards and Product standards.

7 Conclusions

The GTEM cell attracted much attention from electronic product manufacturers and EMC test laboratories in the early 1990s. In parallel with publication of this Good Practice Guide in 2003, an IEC Standard including the use of GTEM cells is being finalised. Once it is accepted as a viable alternative test facility for full compliance EMC testing its continued use will be assured. The aim of this Guide is to give guidance on the practical use of GTEM cells. In particular, investigations have been performed to probe the response of the GTEM cell for emission and immunity measurements for frequencies in the gigahertz range.

One main advantage of the GTEM cell is that it simulates a free-field environment and does not cause a doubling of emitted field that occurs on a ground plane site. However, this doubling is created in post-processing of the GTEM results whilst the OATS remains the standard. CISPR is considering the Fully Anechoic Room as an alternative, in which case the GTEM result could be directly compared with the free-space limits of a FAR standard. Another fundamental benefit of the GTEM method is that the radiation on the surface of a sphere around an EUT is effectively measured, whereas an OATS measurement is limited to an azimuth rotation, with a very small angle of elevation covered (only below about 400 MHz) by height scanning.

It is apparent in the emission results that ambient interference on the OATS obscures the intended measurement results, whereas the result is unaffected in the GTEM cell. The uncertainty of emission measurements in the GTEM cell may appear to be excessive, but it is of a similar order to the variation that can be found when measuring the same product on different OATS. Whereas the uncertainty of an OATS measurement is unacceptably high in the presence of ambient RF, the GTEM cell does not suffer from this problem.

One of the biggest contributions to the uncertainty of radiated emissions measurements is from power and data leads connected to the EUT and there was a fear that the GTEM cell would be unsuitable at higher frequencies because of the over-modding. It appears that the effects of over-modding are not excessive and that the effect of cables is minimal above 1 GHz, leading to the conclusion that the use of GTEM cells above 1 GHz is viable.

Generally, it can be concluded from the measurements performed so far, that the GTEM cell can be used up to 2.3 GHz for immunity tests (MEB 1750 GTEM cell) and at least up to 4.2 GHz for emission tests. The upper useable frequency of GTEM cells for immunity measurements appears to be determined by their poor cross-polar performance rather than by field non-uniformity.

8 References

- [1] Emission and Immunity Measurements and Production of Best Practice Guide on GTEM Cells used for EMC measurements, National Physical Laboratory and York EMC Services Ltd, Final Report March 2003. PDF file available at www.npl.co.uk (Publications) and www.yorkemc.co.uk (Research).
- [2] IEC 61000-4-20. Electromagnetic Compatibility (EMC) – Part 4: Testing and measurement techniques. Section 20: Emission and Immunity Testing in Transverse Electromagnetic (TEM) Waveguides. Committee Draft CISPR/A/278/CD.
- [3] IEC 61000-4-3. Electromagnetic Compatibility (EMC) – Part 4: Testing and measurement techniques. Section 3: Radiated, radio frequency, electromagnetic field immunity test. International Electrotechnical Commission, Geneva, Switzerland.
- [4] B. E. Roseberry and R. B. Schulz. A parallel-strip line for testing of RF susceptibility. *IEEE Transactions on Electromagnetic Compatibility*, EMC-7:142-150, June 1965.
- [5] M. L. Crawford. Generation of standard EM fields using TEM transmission cells. *IEEE Transactions on Electromagnetic Compatibility*, EMC-16: 189-195, November 1974.
- [6] D. Hansen, P. Wilson, D. Königstein, and H. Schaer. A broadband alternative EMC test chamber based on a TEM-cell anechoic-chamber hybrid concept. In *Proceedings of the 1989 International Symposium on Electromagnetic Compatibility*, pages 133-137, Nagoya, Japan, September 1989.
- [7] F. Gassmann, H. Haldemann, and C. Zehntner. Design and performance of a very large GTEM cell. IEEE, Austin, August 1997.
- [8] B. G. Loader, M. J. Alexander, and J. Blackburn. The longitudinal field in the GTEM 1750 cell and the nature of the termination. *EuroEMC*, Sorrento, Italy, September 2002.
- [9] G. Mönich and J. Krause. Draht- und glasfaserlose Feldhomogenitäts-messungen in TEM-Zellen. In *EMV '98, 6. Int. Fachmesse und Kongreß für Elektromagnetische Verträglichkeit*, Düsseldorf, Germany, February 1998.
- [10] A. Nothofer, A.C. Marvin, and J.F. Dawson. Indirect Measurement of Field Uniformity in TEM Cells Including Cross-Polar Field Components. In *13th International Zurich Symposium on Electromagnetic Compatibility*, Zurich, Switzerland, February 1999.
- [11] CISPR Pup. 22. (BS) EN 55022. Limits and methods of measurement of radio disturbance characteristics of information technology equipment.
- [12] Angela Nothofer. *Cross-polar coupling in GTEM cells used for radiated emission measurements*. PhD thesis, University of York, Department of Electronics, December 2000.

- [13] CISPR 16-4 (2002-05) Specification for radio disturbance and immunity measuring apparatus and methods - Part 4: Uncertainty in EMC measurements
- [14] United Kingdom Accreditation Service. LAB34: The Expression of Uncertainty in EMC Testing. Edition 1, August 2002.
- [15] Sisir K. Das and B. K. Sinha. Numerical solution of higher order mode cut-off frequencies in symmetric TEM cells using finite element method. *IEEE Transactions on Electromagnetic Compatibility*, EMC-32(4): 264-268, November 1990.
- [16] Douglas A. Hill. Bandwidth limitations of TEM cells due to resonances. *Journal of Microwave Power*, 18(2):1181-195, 1983.
- [17] Claude M. Weil and Lucian Gruner. Higher-order mode cutoff in rectangular striplines. *IEEE Transactions on Microwave Theory and Techniques*, MTT-32(6):638-641, June 1984.
- [18] Perry F. Wilson and Mark T. Ma. Simple approximate expressions for higher order mode cutoff and resonant frequencies in TEM cells. *IEEE Transactions on Electromagnetic Compatibility*, EMC-28:125-130, August 1986.
- [19] Myron L. Crawford, John L. Workman, and Curtis L. Thomas. Generation of EM susceptibility test fields using a large absorber-loaded TEM cell. *IEEE Transactions on Instrumentation and Measurement*. IM-26(3):225-230, September 1977.
- [20] Myron L. Crawford, John L. Workman, and Curtis L. Thomas. Expanding the bandwidth of TEM cells for EMC measurements. *IEEE Transactions on Electromagnetic Compatibility*, EMC-20(3):368-375, August 1978.
- [21] R. Lorch and G. Mönich. Mode suppression in TEM cells. In *1996 IEEE International Symposium on Electromagnetic Compatibility*, pages 40-42, Santa Clara, CA, USA, August 1996.

9 Glossary

Anechoic material: Any material that exhibits the property of absorbing, or otherwise reducing, the level of electromagnetic energy reflected from that material.

Broadband line termination: A termination that combines a low-frequency discrete component load, to match the characteristic impedance of the TEM waveguides (typically 50 Ω), and a volume of high-frequency anechoic material.

CENELEC: Comité Européen de Normalisation **E**lectro-technique (European Committee for Electrotechnical Standardization)

CISPR: Comité International Spécial des **P**erturbations **R**adioélectriques (International Special Committee on Radio Interference)

CNE: Comparison Noise Emitter, CNE III is a version with an operating frequency range of 1 MHz to 1000 MHz, CNE VII is a version operating from 1 GHz to 7 GHz.

Correlation algorithm: A mathematical routine for converting TEM waveguide voltage measurements to open area test site (OATS) or free space field levels.

CW: Continuous Wave

DUT: Device Under Test

EC: European Community

EMC: Electromagnetic Compatibility. The ability of an equipment or system to function satisfactorily in its electromagnetic environment without introducing intolerable electromagnetic disturbances to anything in that environment.

EMI: Electromagnetic Interference

EN: Euro Norm

EU: European Union

EUT: Equipment Under Test

FAR: Fully Anechoic Room

GTEM: Gigahertz Transverse Electromagnetic (GTEM is also used in the text as an abbreviation for GTEM Cell).

IEC: International Electrotechnical Commission

NPL: National Physical Laboratory, Teddington, UK

OATS: Open Area Test Site

OJ, OJEC: Official Journal of the European Communities

RAM: RF Absorbing Material (in this context, carbon loaded polyurethane foam pyramids)

REUTE: Representative EUT for Emission

REUTI: Representative EUT for Immunity

RF: Radio Frequency

Septum: The inner conductor of a transmission line system, often flat in the case of a rectangular cross section (as in the TEM and GTEM cell). The septum may be positioned symmetrically (TEM cell) or asymmetrically (GTEM cell) with respect to the outer conductor.

TEM: Transverse Electromagnetic. The TEM mode is the waveguide mode in which the electric and magnetic field components in direction of propagation are zero.

TEM cell: An enclosed TEM waveguide, often a rectangular coaxial line, in which a wave is propagated in the TEM mode. The outer conductor completely encloses the inner conductor.

TEM waveguide: Open or closed transmission line system, in which a wave is propagating in the TEM mode.

UKAS: United Kingdom Accreditation Service

YES: York EMC Services Ltd

Appendix 1 Higher order modes in TEM waveguides

The upper frequency range of a TEM cell is limited by higher order modes and their resonances, because these perturb the field uniformity and restrict the analysis of the measurement results. These higher order modes can be divided into essential modes necessary to fulfil the boundary conditions of the waveguide, and non-essential modes excited by geometric distortions like wall imperfections or the equipment under test.

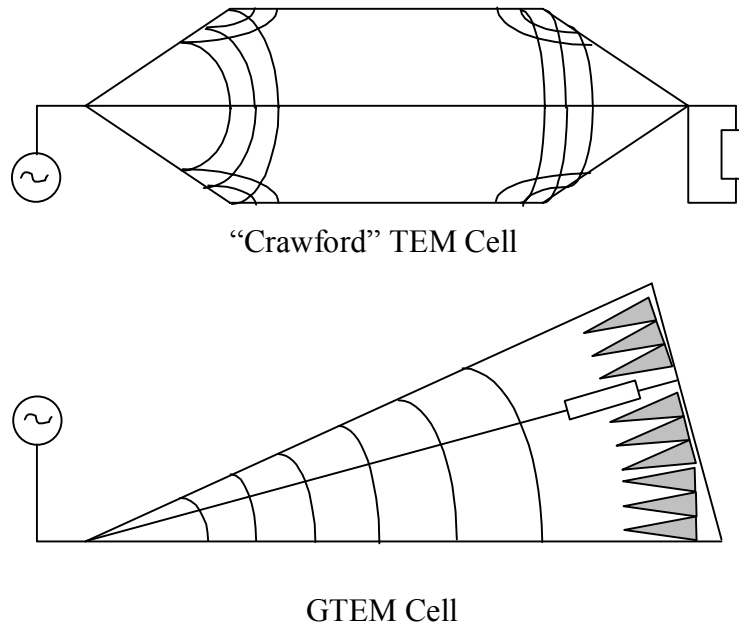

Figure 31: Wave propagation in a Crawford and a GTEM cell

In classic two-port TEM cells, non-essential modes are excited at the transitions between the tapered and the parallel part of the cell (see Figure 31). Therefore, to avoid the transitions, tapered cells like the GTEM were developed. Non-essential modes appear usually at higher frequencies than the first essential mode.

In TEM waveguides, the cut-off frequencies for essential higher order modes are determined by the dimensions of the cross section. In all generally used TEM cells the first significant higher order mode with the lowest cut-off frequency is the first order TE mode (TE_{10}). According to [5], for the classic Crawford cell with a square cross section, the TE_{10} mode cut-off frequency $f_{c,10}$ is given by:

$$f_{c,10} = \frac{c}{2w}$$

where c is the speed of light and w is the width of the TEM cell cross section. Calculations of higher order mode frequencies in TEM cells with different geometries can be found in the literature (e.g. [15], [16], [17], [18]).

The equation above leads to a TE_{10} mode cut-off frequency of 500 MHz for a small TEM cell with a width of 30 cm. As the recommended test volume of a TEM cell is a third of the septum height, a cell of this size (with a septum height of 15 cm) would provide a test volume of 5 cm height. This is sufficient only for small test objects such as measurements of Integrated Chips. Higher order modes in TEM cells appear at sharply defined resonances, and there may be frequency areas between the resonances where the TEM cell is still useable.

In [19] and [20] Crawford introduced absorber loaded TEM cells with an extended bandwidth. In the first paper, absorbers are placed in a large (3 m x 3 m x 6 m) TEM cell increasing its useful frequency range up to 100 MHz. In the second paper this is applied to a smaller cell (1 m x 2 m x 6 m) doubling its useful frequency limit from 250 MHz to 500 MHz. Here pyramidal absorbers were placed at the bottom and under the ceiling of the cell.

Another approach to dampen higher order modes was presented in [21] where the septum was split into two thin sheets and absorbing material was placed in between. In this paper a cell like a Crawford cell without the parallel region, with a central height of 28.4 cm was used. The frequency limit of this cell could be extended from 450 MHz to 670 MHz, using the split septum filled with absorbing material. An even higher frequency range of up to 1000 MHz was achieved by placing absorbing material behind longitudinal slots in the walls.

Appendix 2 Field uniformity measurements

A2.1 Definition of uniform area

The following text in italics is extracted from IEC 61000-4-20 dated August 2002. It is referred to in Section 3.1 of this Guide.

Dimensions	Layout and number of measurement points	Number of points to fulfill the -0 dB to +6 dB criterion
1.5 m x 1.5 m	4 x 4 = 16	12
1.0 m x 1.5 m	3 x 4 = 12	9
1.0 m x 1.0 m	3 x 3 = 9	7
0.5 m x 1.0 m	2 x 3 = 6	5
0.5 m x 0.5 m	4 + 1(center) = 5	4
0.25 m x 0.25 m	4 + 1(center) = 5	4
0 m x 1.5 m	2 x 4 = 8	6

Table 4: Uniform area calibration points

Areas not listed in this table shall be calibrated using a grid number defined by the smallest 0.5 m grid fully containing the proposed area (e.g., a 30 cm x 30 cm area using 4 + 1(centre) = 5 points, a 80 cm x 80 cm area using 3 x 3 = 9 points, and a 1.2 m x 0.8 m area using 4 x 3 = 12 points). Grid spacing shall be uniform along each side (e.g., 1.2 m x 0.8 m uniform area shall use a 0.3 m x 0.26 m basic grid size). As outlined above, at least 75% of the measurement points shall fulfill the uniformity criterion (e.g. for a 12 point grid 9 point compliance is required). In the test setup, the EUT shall have its face to be illuminated coincident with this plane.

Within this area the following requirements have to be met:

- *The magnitude of the resultant electric field strength over the defined area is within - 0 dB to + 6 dB of the nominal resultant field, over at least 75 % of the measured points.*
- *The magnitudes of both secondary (unintended) electric field components are at least 6 dB less than the resultant field strength, over at least 75 % of the measured points*

The 75 % of points fulfilling the first requirement need not be identical with the 75 % fulfilling the second requirement. At different frequencies, different measured points may be within the tolerance. The tolerance has been expressed as - 0 dB to + 6 dB to ensure that the field strength does not fall below nominal. The 6 dB tolerance is considered to be the minimum achievable in practical test facilities.

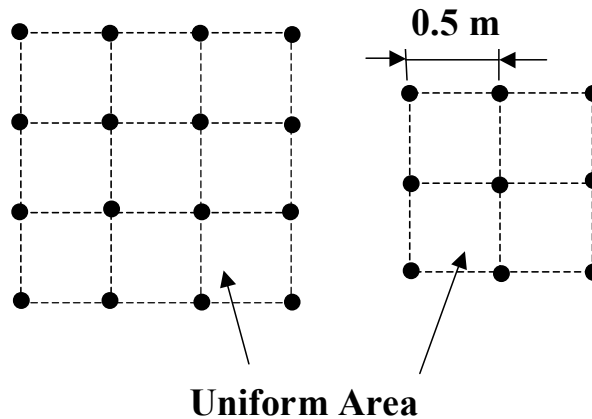

Figure 32: Calibration points for the uniform area with a 1.5 m x 1.5 m or a 1 m x 1 m grid

A resultant electric field strength tolerance greater than + 6 dB up to + 10 dB but not less than – 0 dB, or a secondary electric field component up to – 2 dB of the resultant field, is allowed for a maximum of 3 % of the test frequencies (at least one frequency), provided that the actual tolerance and frequencies are stated in the test report.

The 75% rule and the 3% rule are concessions agreed by the standards committee for pragmatic reasons.

A2.2 Procedure to measure uniform field area

The procedure for carrying out the calibration is known as the “constant forward power” method and is as follows:

1. *Position the isotropic field strength sensor at one of the points in the grid;*
2. *Apply a forward power to the TEM waveguide input port so that the electric field strength of the resultant field component is in the range 3 V/m to 10 V/m, through the frequency range specified, and record all the forward power, primary and secondary components field strength, and resultant field strength readings;*
3. *With the same forward power, measure and record the resultant, primary, and secondary field strengths at the remaining grid points;*
4. *Taking all grid points into consideration, delete a maximum of 25 % (4 of 16, 2 of 9, 1 of 5) of those points with the greatest deviation of the resultant field at the point with respect to the nominal (wanted) resultant field strength;*
5. *The resultant field magnitude of the remaining points shall lie within a range of 6 dB. The level of the secondary field components shall not exceed –6 dB of the resultant field at each of these points;*
6. *Of the remaining points, take the location with the lowest resultant field strength as reference (this ensures the –0 dB to +6 dB requirement is met);*
7. *From knowledge of the forward power and the field strength, the necessary forward power for the required test field strength can be calculated (e.g. if at a given point 81 W gives 9 V/m, then 9 W is needed for 3 V/m). This shall be recorded.*

Recommended sale price £50.00